



Contact SAMSUNG WORLDWIDE

If you have any questions or comments relating to Samsung products, please contact the SAMSUNG customer care center.

Comuníquese con SAMSUNG WORLDWIDE

Si desea formular alguna pregunta o comentario en relación con los productos de Samsung, comuníquese con el centro de atención al cliente de SAMSUNG.

| Country | Customer Care Center ☎ | Web Site | Address |
|---------|--------------------------|-----------------|---|
| CANADA | 1-800-SAMSUNG (726-7864) | www.samsung.com | Samsung Electronics Canada Inc., Customer Service 55 Standish Court Mississauga, Ontario L5R 4B2 Canada |
| U.S.A | 1-800-SAMSUNG (726-7864) | www.samsung.com | Samsung Electronics America, Inc. 85 Challenger Road Ridgefield Park, NJ 07660-2112 |



SERIES **5**
5000

LED TV User Manual

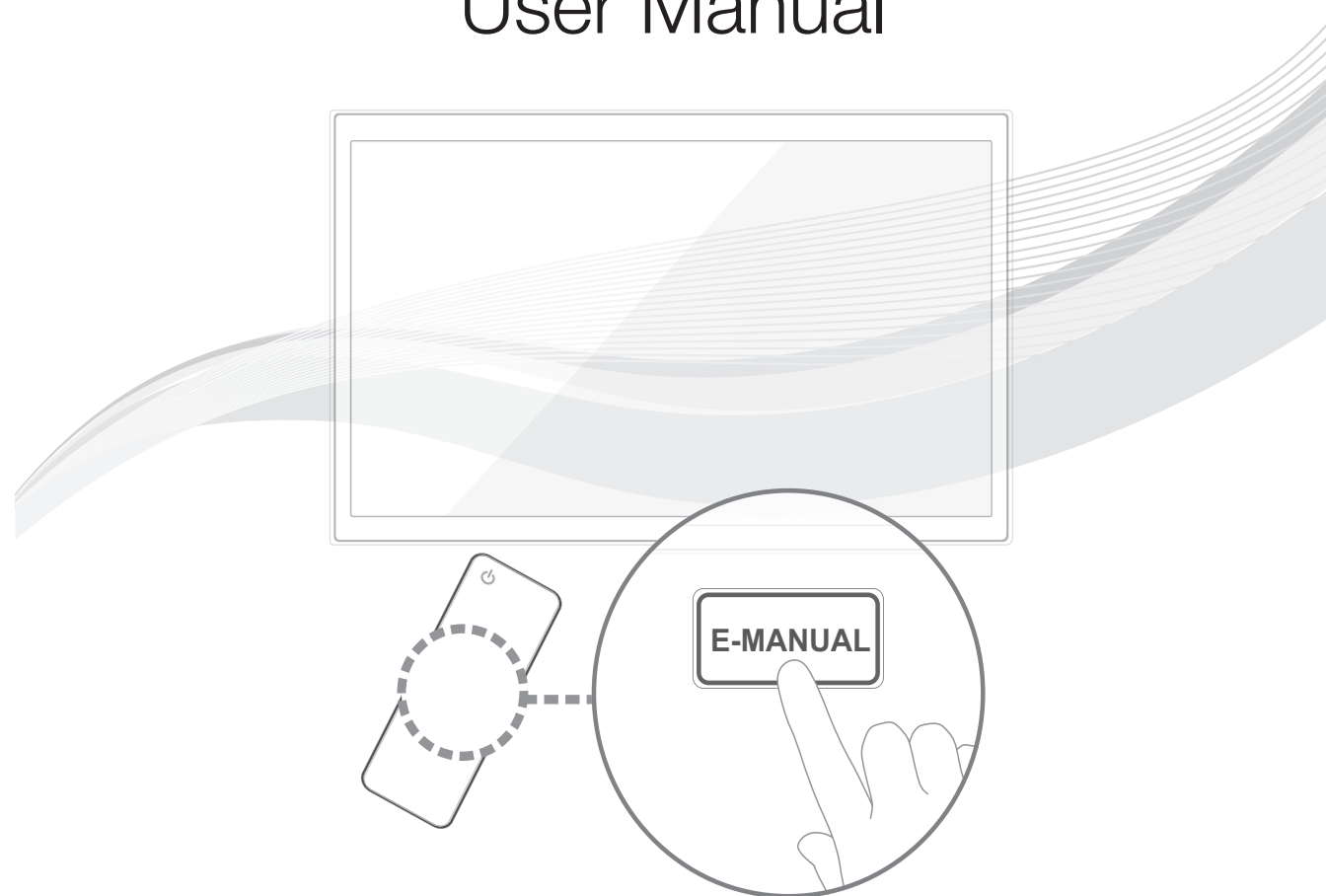

imagine the possibilities

Thank you for purchasing this Samsung product.
To receive more complete service, please register
your product at

www.samsung.com/register

Model _____ Serial No. _____



For more information about how to use e-Manual (P. 14)

Figures and illustrations in this User Manual are provided for reference only and may differ from actual product appearance. Product design and specifications may be changed without notice.

Important Warranty Information Regarding Television Format Viewing

See the warranty card for more information on warranty terms.

Wide screen format LED Displays (16:9, the aspect ratio of the screen width to height) are primarily designed to view wide screen format full-motion video. The images displayed on them should primarily be in the wide screen 16:9 ratio format, or expanded to fill the screen if your model offers this feature and the images are constantly moving. Displaying stationary graphics and images on screen, such as the dark sidebars on non-expanded standard format television video and programming, should be limited to no more than 5% of the total television viewing per week.

Additionally, viewing other stationary images and text such as stock market reports, video game displays, station logos, web sites or computer graphics and patterns, should be limited as described above for all televisions. Displaying stationary images that exceed the above guidelines can cause uneven aging of LED Displays that leave subtle, but permanent burned-in ghost images in the LED picture. To avoid this, vary the programming and images, and primarily display full screen moving images, not stationary patterns or dark bars. On LED models that offer picture sizing features, use these controls to view different formats as a full screen picture.

Be careful in the selection and duration of television formats you use for viewing. Uneven LED aging as a result of format selection and use, as well as burned-in images, are not covered by your Samsung limited warranty.

• SAMSUNG ELECTRONICS NORTH AMERICAN LIMITED WARRANTY STATEMENT

Subject to the requirements, conditions, exclusions and limitations of the original Limited Warranty supplied with Samsung Electronics (SAMSUNG) products, and the requirements, conditions, exclusions and limitations contained herein, SAMSUNG will additionally provide Warranty Repair Service in the United States on SAMSUNG products purchased in Canada, and in Canada on SAMSUNG products purchased in the United States, for the warranty period originally specified, and to the Original Purchaser only.

The above described warranty repairs must be performed by a SAMSUNG Authorized Service Center. Along with this Statement, the Original Limited Warranty Statement and a dated Bill of Sale as Proof of Purchase must be presented to the Service Center. Transportation to and from the Service Center is the responsibility of the purchaser. Conditions covered are limited only to manufacturing defects in material or workmanship, and only those encountered in normal use of the product.

Excluded, but not limited to, are any originally specified provisions for, in-home or on-site services, minimum or maximum repair times, exchanges or replacements, accessories, options, upgrades, or consumables.

For the location of a SAMSUNG Authorized Service Center, please call toll-free:

- In the United States : 1-800-SAMSUNG (1-800-726-7864)
- In Canada : 1-800-SAMSUNG

Still image warning

Avoid displaying still images (such as jpeg picture files), still image elements (such as TV channel logos, stock or news bars at the screen bottom etc.), or programs in panorama or 4:3 image format on the screen. Constantly displaying still pictures can cause image burn-in on the LED screen, which will affect image quality. To reduce risk of this effect, please follow the recommendations below:

- Avoid displaying the same TV channel for long periods.
- Always try to display any image in full screen. Use the TV set's picture format menu for the best possible match.
- Reduce brightness and contrast values to the minimum required to achieve the desired picture quality. Exceeding the minimum required values may speed up the burn-in process.
- Frequently use all TV features designed to reduce image retention and screen burn-in. Refer to appropriate e-Manual sections for details.

Securing the Installation Space

Keep the required distances between the TV, the wall, and other objects to ensure proper ventilation. Failing to do so may result in a fire or a problem with the TV caused by an increase in its internal temperature.

When using a stand or wall-mount, use parts provided by Samsung Electronics only.

- If you use parts provided by another manufacturer, it may result in a problem with the product or an injury due to the product falling.

Installation with a stand.

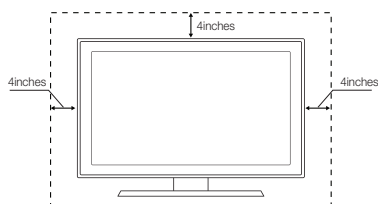

Installation with a wall-mount.

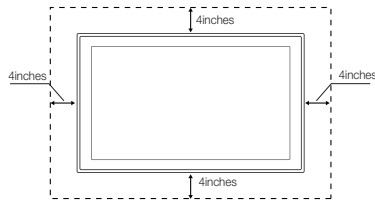



Other Warnings

The actual appearance of the TV may differ from the images in this manual, depending on the model.

Be careful when you touch the TV. Some parts can be somewhat hot.

Accessories

 Please make sure the following items are included with your TV. If any items are missing, contact your dealer.

 The items' colors and shapes may vary depending on the model.

- Remote Control (AA59-00463A) & Batteries (AAA x 2)
- Owner's Instructions
- Warranty Card / Safety Guide
- Cleaning Cloth (BN63-01798B)
- Power Cord



Component Adapter (BN39-01154W)

Input Cables (Sold Separately)

To purchase the RS232 cable, contact www.SamsungParts.com.



RS232 (AA39-00311A)



HDMI



HDMI-DVI



Audio



Component



Composite (AV)

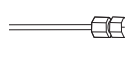

Coaxial (RF)

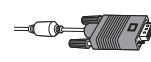



VGA

Viewing the Control Panel

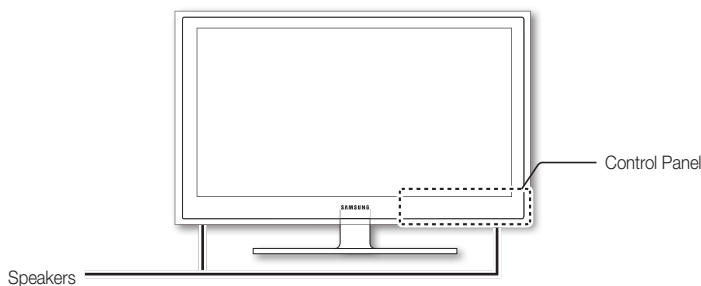
 The product color and shape may vary depending on the model.



| | |
|---|---|
| Remote control sensor | Aim the remote control towards this spot on the TV. |
| Power Indicator | Blinks and turns off when the power is on and lights up in standby mode. |
| SOURCE  | Toggles between all the available input sources. In the on-screen menu, use this button as you would use the ENTER  button on the remote control. |
| MENU | Displays an on-screen menu, the OSD (on screen display) of your TV's features. |
| - VOL + | Adjusts the volume. In the OSD, use the - VOL + buttons as you would use the ◀ and ▶ buttons on the remote control. |
| ▼ CH ▲ | Changes the channels. In the OSD, use the ▼ CH ▲ buttons as you would use the ▼ and ▲ buttons on the remote control. |
|  (Power) | Turns the TV on or off. |

Standby mode

Your TV enters Standby mode when you turn it off and continues to consume a small amount of electric power. To be safe and to decrease power consumption, do not leave your TV in standby mode for long periods of time (when you are away on a holiday, for example). It is best to unplug the power cord.

Installing the TV Stand (UN22D5000 / UN22D5010)

Components

When installing the stand, use the provided components and parts.

A 1 EA

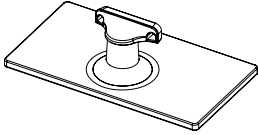

B

 x2 (M4 X L12)

Stand (depending on the model)

Screws

1



A

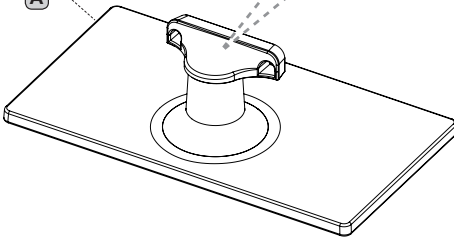

2

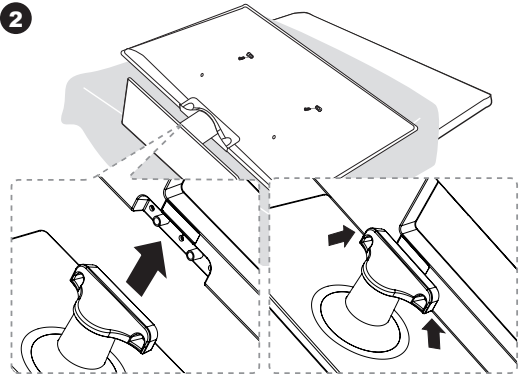

 Place a soft cloth over the table to protect the TV, and then place the TV on the cloth screen side down.

 Insert the Stand Guide into the slot of TV bottom side.

3

C  x2
(M4 X L12)

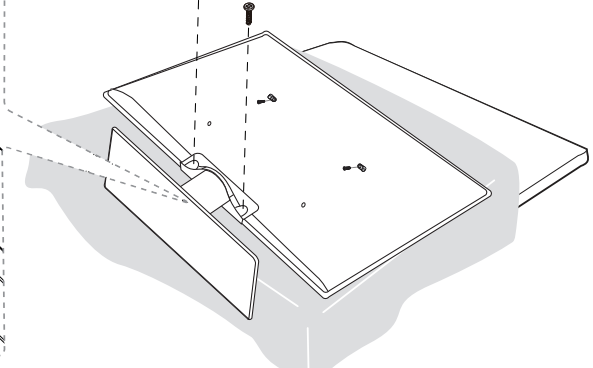
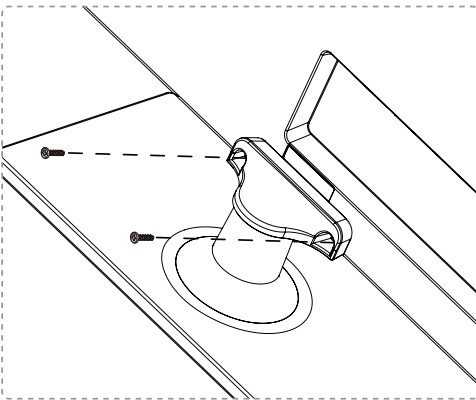

Caution



➤ Make sure to distinguish between the front and back of each component when assembling them.

Installing the TV Stand (UN27D5000)

Components

When installing the stand, use the provided components and parts.

A 1 EA

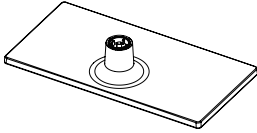

B 1 EA

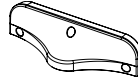

C x6 (M4 X L12)



Stand (depending on the model)

Guide Stand

Screws

1

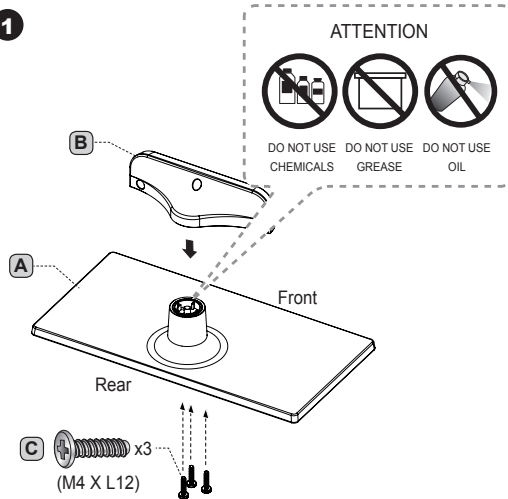

2

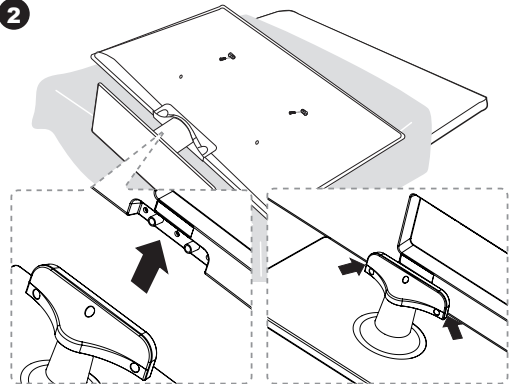

- Place a soft cloth over the table to protect the TV, and then place the TV on the cloth screen side down.
- Insert the Stand Guide into the slot of TV bottom side.

3 Side View

(Correct assembly)

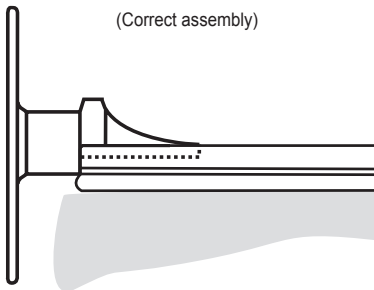

(Incorret assembly)

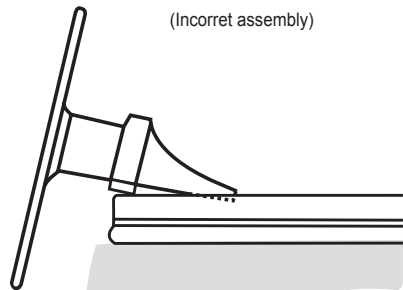

4

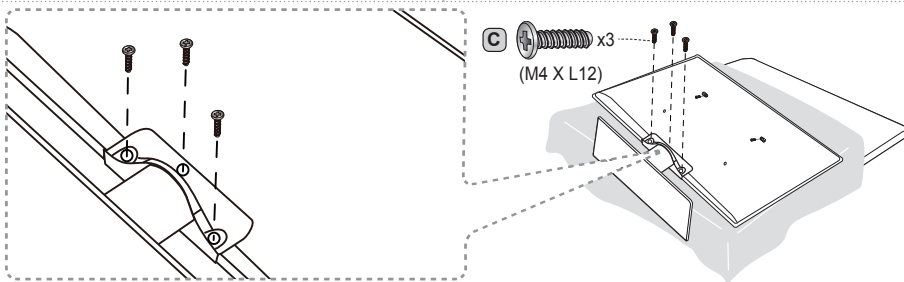

Caution



> Make sure to distinguish between the front and back of each component when assembling them.

Installing the Wall Mount



Wall or Ceiling Mounting

The product should be mounted on a wall or ceiling only as recommended by the manufacturer. Unless it is correctly mounted, the product may slide or fall, causing serious injury to a child or adult, and serious damage to the product.

Installing the Wall Mount Kit

The wall mount kit (sold separately) allows you to mount the TV on the wall.

For detailed information on installing the wall mount, see the instructions provided with the wall mount items. Contact a technician for assistance when installing the wall mount bracket. Samsung Electronics is not responsible for any damage to the product or injury to yourself or others if you elect to install the wall mount on your own.

Wall Mount Kit Specifications (VESA)

Install your wall mount on a solid wall perpendicular to the floor. Before attaching the wall mount to building materials other than plaster board, please contact your nearest dealer for additional information. If you install the TV on a ceiling or slanted wall, it may fall and result in severe personal injury.

NOTE

- Standard dimensions for wall mount kits are shown in the table below.
- Samsung wall mount kits contain a detailed installation manual and all parts necessary for assembly.
- Do not use screws that do not comply with the VESA standard screw specifications.
- Do not use screws that are longer than the standard length or do not comply with the VESA standard screw specifications. Screws that are too long may cause damage to the inside of the TV set.
- For wall mounts that do not comply with the VESA standard screw specifications, the length of the screws may differ depending on the wall mount specifications.
- Do not fasten the screws too firmly. This may damage the product or cause the product to fall, leading to personal injury. Samsung is not liable for these kinds of accidents.
- Samsung is not liable for product damage or personal injury when a non-VESA or non-specified wall mount is used or the consumer fails to follow the product installation instructions.
- Do not mount the TV at more than a 15 degree tilt.
- Always have two people mount the TV on a wall.

| Product Family | TV size in inches | VESA scw hole specs (A * B) in millimeters | Standard Screw | Quantity |
|----------------|-------------------|--|----------------|----------|
| LED-TV | 19~22 | 75 X 75 | M4 | 4 |
| | 27 | 200 X 100 | | |
| | 32~40 | 200 X 200 | M8 | |
| | 46~55 | 400 X 400 | | |
| | 60~65 | 600 X 400 | | |

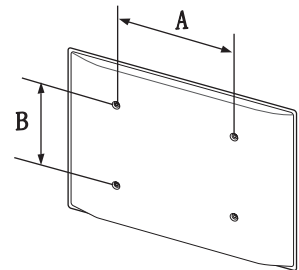

Do not install your Wall Mount Kit while your TV is turned on. It may result in personal injury due to electric shock.

Remote Control Buttons

 This remote control has Braille points on the Power, Channel, and Volume buttons and can be used by visually impaired persons.

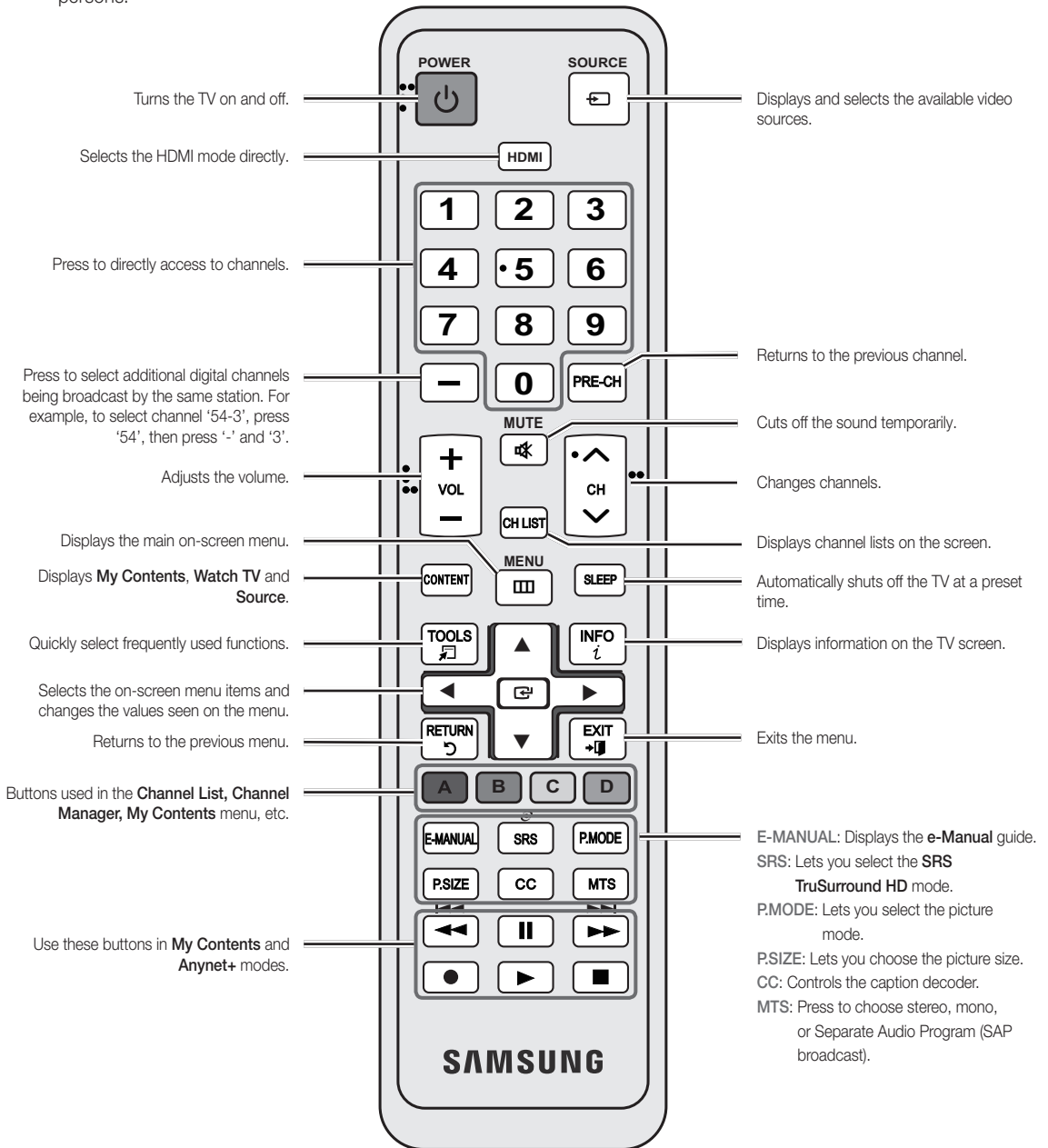

Installing batteries (Battery size: AAA)

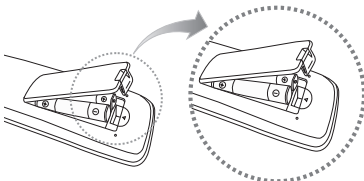

NOTE

- Use the remote control within 23~33 feet from the TV.
- Bright light may affect the performance of the remote control. Avoid using when near fluorescent lights or neon signs.
- The color and shape may vary depending on the model.

How to Navigate Menus

Before using the TV, follow the steps below to learn how to navigate the menu and select and adjust different functions.

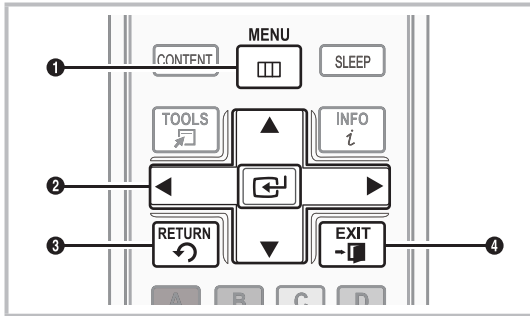

- ❶ **MENU** button: Displays the main on-screen menu.
- ❷ **ENTER** / Direction button: Move the cursor and select an item. Confirm the setting.
- ❸ **RETURN** button: Returns to the previous menu.
- ❹ **EXIT** button: Exits the on-screen menu.

How to Operate the OSD (On Screen Display)

The access steps may differ depending on the selected menu.

| | | |
|----------|----------------|--|
| 1 | MENU | The main menu options appear on the screen: Picture, Sound, Channel, System, Support. |
| 2 | ▲ / ▼ | Select an icon or option with the ▲ or ▼ button. |
| 3 | ENTER ↵ | Press ENTER ↵ to access the sub-menus. |
| 4 | ▲ / ▼ | Select the desired submenu with the ▲ or ▼ button. |
| 5 | ◀ / ▶ | Adjust the value of an item with the ◀ or ▶ button. The adjustment in the OSD may differ depending on the selected menu. |
| 6 | ENTER ↵ | Press ENTER ↵ to confirm the selection. |
| 7 | EXIT → | Press EXIT. |

🔗 For best cable connection to this product, be sure to use cables with a maximum thickness as below:

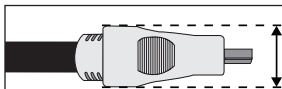

- Maximum thickness - 0.55 inches (14mm)

Connecting to an Antenna or Cable Connection

Connecting the power cord and an antenna or cable connection

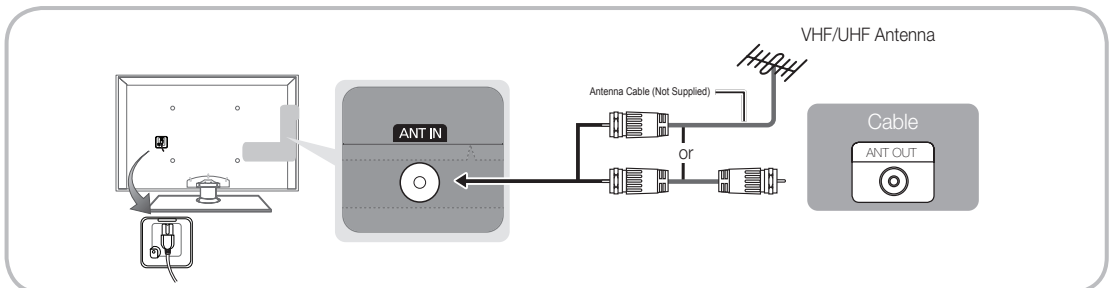















Plug & Play (Initial Setup)



When you turn the TV on for the first time, a sequence of on-screen prompts will assist in configuring basic settings. To turn on the TV, press the **POWER**  button.

 **Plug & Play** is available only when the **Source** is set to TV.

 To return to the previous step in the **Plug & Play** sequence, press the red button on your remote.

| | | | |
|----------|--|--|---|
| 1 | Selecting the OSD Language | Press the ◀ or ▶ button, and then press the ▲ or ▼ button to select a language. Press ENTER  when done. |  |
| 2 | Selecting the usage mode | Press the ◀ or ▶ button to select, and then press the ENTER  button. <ul style="list-style-type: none">Select the Home Use mode. Store Demo mode is for retail environments. | |
| 3 | Setting the Clock Mode | Press the ◀ or ▶ button. Press the ▲ or ▼ button to select Auto or Manual , and then press ENTER  . <ul style="list-style-type: none"> If you selected Auto, you'll select the time zone where you live next, and then select whether to turn DST (Daylight Savings Time) On or Off. If you selected Manual, you'll use the number buttons or ▲ or ▼ button to set the date and time. Use the ◀ or ▶ button to move between entry fields. | |
| 4 | Selecting search options for auto tuning | Press the ▲ or ▼ button to select Air or Cable , and then press ENTER  . A check appears on your selection. Select Next , and then press the ENTER  button. You can check both if you have both connected. <ul style="list-style-type: none"> If you selected Cable, you'll go to the Cable System screen. Use the ▲ or ▼ button to select Digital or Analog, and then press ENTER . Use the ▲ or ▼ button to select the correct cable signal format - STD, HRC, or IRC - and then press ENTER . Most cable systems use STD. Select the correct cable signal format for both the Digital and Analog systems. When done, select Search, and then press ENTER . | |
| 5 | Selecting and memorizing channels | The channel search will start automatically. This can take up to 30 minutes. For more information, refer to Channel → Auto Program in the e-Manual . <ul style="list-style-type: none"> Press the ENTER  button at any time to interrupt the memorization process. | |
| 6 | Enjoy your TV. | Press the ENTER  button. | |

If You Want to Reset Plug & Play...

 MENU  → System → Plug & Play → ENTER 

 To change the TV's settings from **Store Demo** to **Home Use** when not in **Plug & Play**, press the volume button on the TV. When you see the volume in the OSD, press and hold **MENU** for 5 sec.

Connecting to an AV Device

Using an HDMI cable or HDMI to DVI Cable: HD connection (up to 1080p)

We recommend using the HDMI connection for the best quality HD picture.

Available devices: DVD player, Blu-ray player, HD cable box, HD satellite receiver (STB).

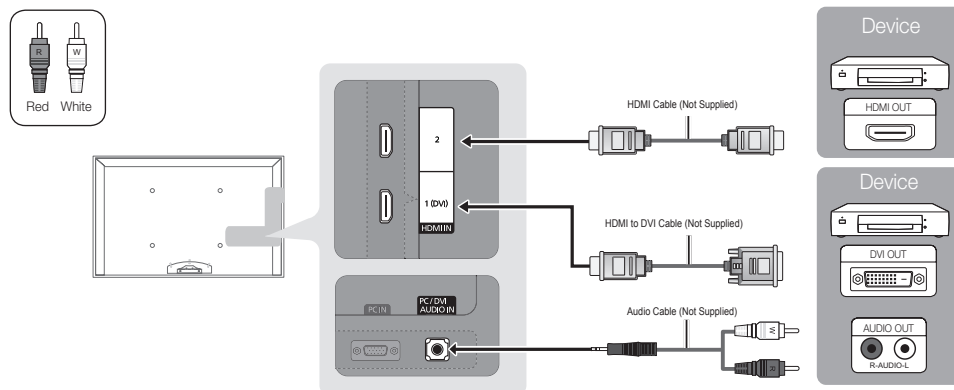

HDMI IN 1 (DVI), 2 / PC/DVI AUDIO IN

- When using an HDMI/DVI cable connection, you must use the **HDMI IN 1 (DVI)** jack for video. A DVD, Blu-ray player, HD cable box, or HD STB satellite receiver may require a DVI-HDMI (DVI to HDMI) cable or DVI-HDMI (DVI to HDMI) adapter. The **PC/DVI AUDIO IN** jack is required for audio.
- Be sure to use an HDMI cable with a thickness of 14 mm or less.
- The picture may not display normally (if at all) or the audio may not work if an external device that uses an older version of HDMI mode is connected to the TV. If such a problem occurs, ask the manufacturer of the external device about the HDMI version and, if out of date, request an upgrade.
- Be sure to purchase a certified HDMI cable. Otherwise, the picture may not display or a connection error may occur.

Using a Component (up to 1080p) or an Audio/Video Cable (480i only)

Available devices: DVD player, Blu-ray player, cable box, STB satellite receiver, VCR

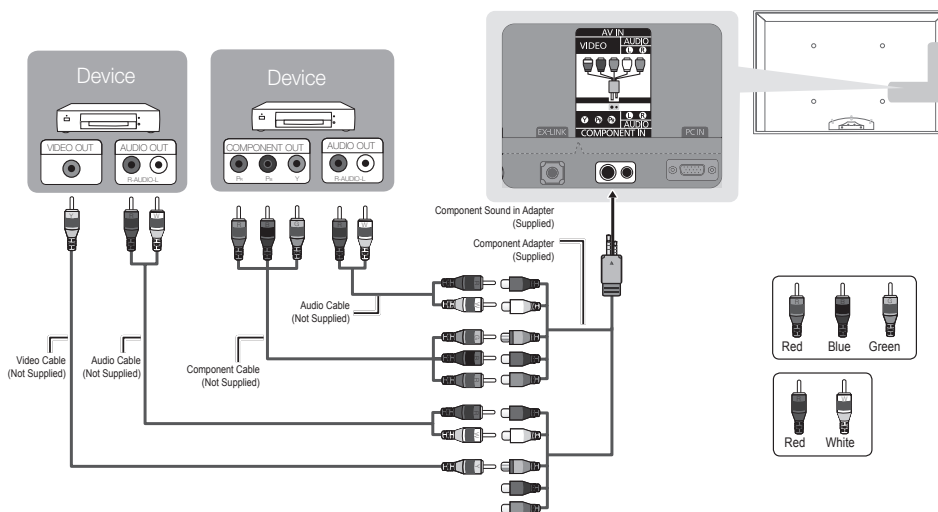

For better picture quality, the Component connection is recommended over the A/V connection.

Connecting to an Audio Device

Using an Optical (Digital) or Headphone Cable Connection

Available devices: Digital Audio System, Amplifier, Home theater

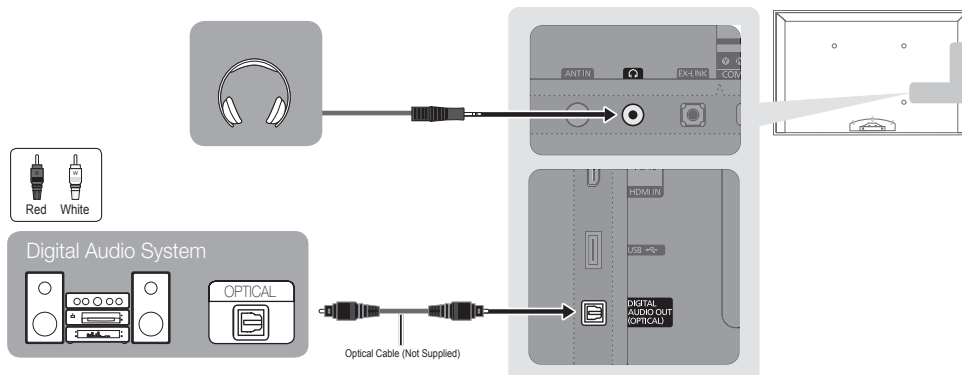

DIGITAL AUDIO OUT (OPTICAL)

- When you connect a Digital Audio System to the **DIGITAL AUDIO OUT (OPTICAL)** jack, decrease the volume of both the TV and the system.
- 5.1 CH (channel) audio is available when you connect the TV to an external device supporting 5.1 CH.
- When the receiver (home theater) is set to on, you can hear sound output from the TV's optical jack. When the TV is receiving a DTV signal, the TV will send 5.1 CH sound to the home theater receiver. When the source is a digital component such as a DVD player / Blu-ray player / cable box / STB (Set-Top-Box) satellite receiver and you connected it to the TV via HDMI, you will only hear 2 CH audio from the home theater receiver. If you want to hear 5.1 CH audio, connect the digital audio out jack from your DVD player/ Blu-ray player / cable box / STB satellite receiver directly to an amplifier or home theater.

Headphones : You can connect your headphones to the headphones output on your set. While the headphones are connected, the sound from the built-in speakers will be disabled.

- Sound function may be restricted when connecting headphones to the TV.
- Headphone volume and TV volume are adjusted separately.

Connecting to a PC

Using an HDMI cable or HDMI to DVI cable or a D-sub cable

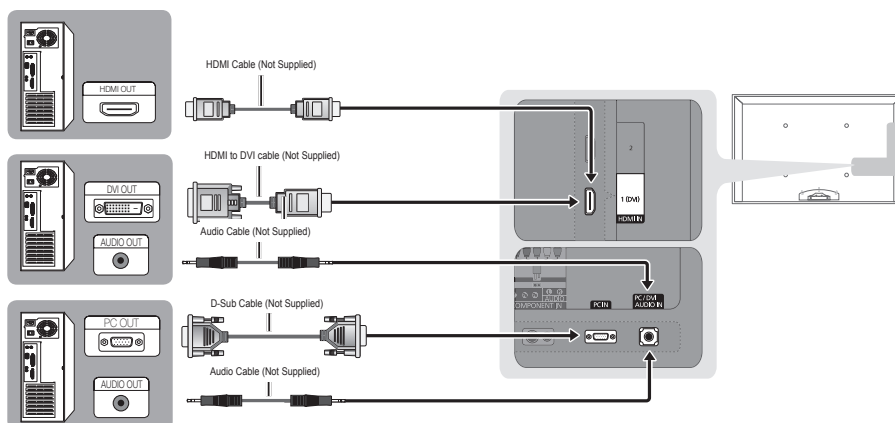

Your PC may not support an HDMI connection.

Display Modes (D-Sub and HDMI/DVI Input)

Optimal PC resolution is 1920 x 1080@60Hz. You can also select one of the standard resolutions listed in the Resolution column. The TV will automatically adjust to the resolution you choose.

| Mode | Resolution | Horizontal Frequency (KHz) | Vertical Frequency (Hz) | Pixel Clock Frequency (MHz) | Sync Polarity (H / V) |
|-----------------------|--------------|----------------------------|-------------------------|-----------------------------|-----------------------|
| IBM | 640 x 350 | 31.469 | 70.086 | 25.175 | +/- |
| | 720 x 400 | 31.469 | 70.087 | 28.322 | -/+ |
| MAC | 640 x 480 | 35.000 | 66.667 | 30.240 | -/- |
| | 832 x 624 | 49.726 | 74.551 | 57.284 | -/- |
| | 1152 x 870 | 68.681 | 75.062 | 100.000 | -/- |
| VESA DMT | 640 x 480 | 31.469 | 59.940 | 25.175 | -/- |
| | 640 x 480 | 37.861 | 72.809 | 31.500 | -/- |
| | 640 x 480 | 37.500 | 75.000 | 31.500 | -/- |
| | 800 x 600 | 37.879 | 60.317 | 40.000 | +/+ |
| | 800 x 600 | 48.077 | 72.188 | 50.000 | +/+ |
| | 800 x 600 | 46.875 | 75.000 | 49.500 | +/+ |
| | 1024 x 768 | 48.363 | 60.004 | 65.000 | -/- |
| | 1024 x 768 | 56.476 | 70.069 | 75.000 | -/- |
| | 1024 x 768 | 60.023 | 75.029 | 78.750 | +/+ |
| | 1152 x 864 | 67.500 | 75.000 | 108.000 | +/+ |
| | 1280 x 1024 | 63.981 | 60.020 | 108.000 | +/+ |
| | 1280 x 1024 | 79.976 | 75.025 | 135.000 | +/+ |
| | 1280 x 800 | 49.702 | 59.810 | 83.500 | -/+ |
| | 1280 x 800 | 62.795 | 74.934 | 106.500 | -/+ |
| | 1280 x 960 | 60.000 | 60.000 | 108.000 | +/+ |
| 1360 x 768 | 47.712 | 60.015 | 85.500 | +/+ | |
| 1440 x 900 | 55.935 | 59.887 | 106.500 | -/+ | |
| 1440 x 900 | 70.635 | 74.984 | 136.750 | -/+ | |
| 1680 x 1050 | 65.290 | 59.954 | 146.250 | -/+ | |
| VESA DMT / DTV CEA | 1920 x 1080p | 67.500 | 60.000 | 148.500 | +/+ |

NOTE

- For HDMI/DVI cable connection, you must use the **HDMI IN 1 (DVI)** jack.
- The interlace mode is not supported.
- The set might operate abnormally if you select a non-standard video format.
- Separate and Composite modes are supported. SOG (Sync On Green) is not supported.

EX-LINK

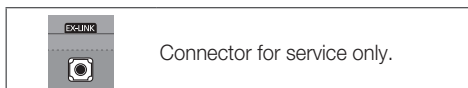

Changing the Input Source

Source

Use to select TV or an external input source such as a DVD player / Blu-ray player / cable box / STB satellite receiver.

1. Press the **SOURCE** button on your remote.
2. Select a desired external input source.

■ TV / Component / PC / HDMI1/DVI / HDMI2 / AV / USB

 You can only choose external devices that are connected to the TV. In **Source**, connected inputs will be highlighted.

 If you want to see connected devices only, move to **Connected** using the ◀ or ▶ button.

 **PC** always stays activated.

 If the connected external devices are not highlighted, press the red button. The TV will search for connected devices.

SOURCE





How to use Edit Name

Edit Name lets you associate a device name to an input source. To access **Edit Name**, press the **TOOLS** button in **Source**. The following selections appear under **Edit Name**:

■ **VCR / DVD / Cable STB / Satellite STB / PVR STB / AV Receiver / Game / Camcorder / PC / DVI PC / DVI Devices / TV / IPTV / Blu-ray / HD DVD / DMA**: Name the device connected to the input jacks to make your input source selection easier.

 If you have connected a PC to the **HDMI IN 1 (DVI)** port with an HDMI cable, select **PC** under **Edit Name** to enter a device name.

 If you have connected a PC to the **HDMI IN 1 (DVI)** port with an HDMI to DVI cable, select **DVI PC** under **Edit Name** to enter a device name.

 If you connected an AV device to the **HDMI IN 1 (DVI)** port with an HDMI to DVI cable, select **DVI Devices** under mode under **Edit Name** to enter a device name.

Information

You can see detailed information about the selected external device.

How to view the e-Manual

E-MANUAL



You can find instructions for your TV's features in the **e-Manual** in your TV. To use, press the **E-MANUAL** button on your remote. Move the cursor using the up/down/right/left buttons to highlight a category, then a topic, and then press the **ENTER** button. The **e-Manual** displays the page you want to see.

You can also access it through the menu:

MENU → **Support** → **e-Manual** → **ENTER**

To return to the **e-Manual** main menu, press the **E-MANUAL** button on the remote.

You cannot use **Try Now** directly if the TV is set to an external input source.

Screen Display

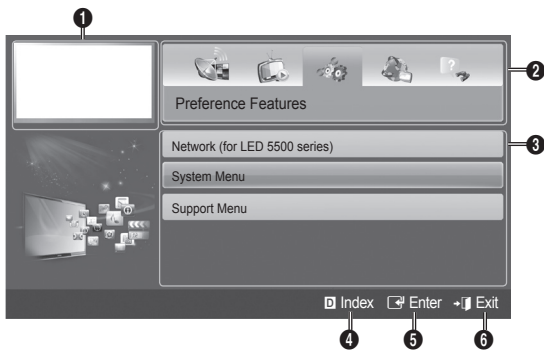

- ❶ Currently displayed video, TV program, etc.
- ❷ The category list. Press ◀ or ▶ button to select the category you want.
- ❸ Displays the sub-menu list. Use the arrow buttons on your remote to move the cursor. Press the **ENTER** button to select the sub-menu you want.
- ❹ **Blue (Index)**: Displays the index screen.
- ❺ **Enter**: Selects a category or sub-menu.
- ❻ **Exit**: Exit the e-Manual.

How to toggle between an e-Manual topic and the corresponding OSD menu(s).

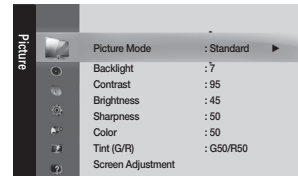
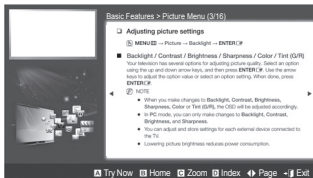

Method 1

1. If you want to use the menu that corresponds to an **e-Manual** topic, press the red button to select **Try Now**.
2. To return to the **e-Manual** screen, press the **E-MANUAL** button.

Method 2

1. Press the **ENTER** button when a topic is displayed. "Do you want to execute this?" appears. Select **Yes**, and then press the **ENTER** button. The OSD window appears.
2. To return to the **e-Manual** screen, press the **E-MANUAL** button.

Viewing the Contents

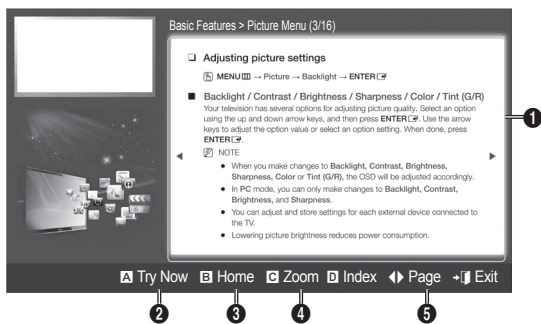

- ❶ Contents Area: Contains the topic contents, if you selected a sub-menu. To move to the previous or next page, press the ◀ / ▶ button.
- ❷ **Try Now:** Displays the OSD menu that corresponds to the topic. To return to the **e-Manual** screen, press the **E-MANUAL** button.
- ❸ **Home:** Moves to the **e-Manual** home screen.
- ❹ **Zoom:** Magnifies a screen. You can scroll through the magnified screen by using ▲ / ▼ buttons.
- ❺ ◀▶ (**Page**): Moves to previous or next page.

Using the Zoom mode

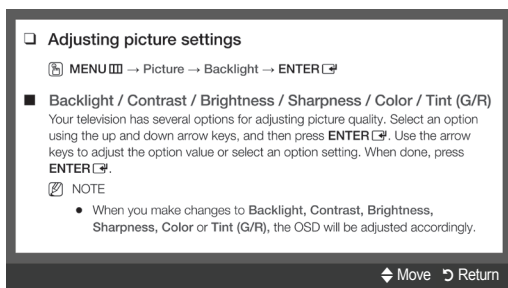

Select **Zoom**, and then press **ENTER** to magnify the screen. You can scroll through the magnified screen by using the ▲ or ▼ buttons.

To return to the screen to normal size, press the **RETURN** button.

How to search for a topic on the index page

1. To search for a topic, press the left or right arrow button to select a letter, and then press **ENTER**. The Index displays a list of topics and keywords that begin with the letter you selected.
 2. Press the up or down arrow button to select a topic or keyword, and then press the **ENTER** button.
 3. The e-Manual page with the topic appears.
- To close the **Index** screen, press the **RETURN** button.

Troubleshooting

If the TV seems to have a problem, first review this list of possible problems and solutions. Also review the Troubleshooting section in the e-Manual. If none of the troubleshooting tips apply, visit samsung.com, and then click on Support, or call Samsung customer service at 1-800-SAMSUNG.

| Issues | Solutions and Explanations |
|--|---|
| The TV will not turn on. | <ul style="list-style-type: none"> • Make sure the AC power cord is securely plugged into the wall outlet and the TV. • Make sure the wall outlet is working. • Try pressing the POWER button on the TV to make sure the problem is not the remote. If the TV turns on, refer to 'Remote control does not work' below. |
| The TV turns off automatically. | <ul style="list-style-type: none"> • Ensure the Sleep Timer is set to Off in the System menu. • If your PC is connected to the TV, check your PC power settings. • Make sure the AC power cord is plugged in securely to the wall outlet and the TV. • When you are watching TV connected to an antenna or cable connection, the TV will turn off after 10 - 15 minutes if there is no signal. |
| There is no picture/video | <ul style="list-style-type: none"> • Check the cable connections. Remove and reconnect all cables connected to the TV and external devices. • Set the video outputs of your external devices (Cable/Set top Box, DVD, Blu-ray etc) to match the TV input connections. For example, if an external device's output is HDMI, it should be connected to an HDMI input on the TV. • Make sure your connected devices are powered on. • Be sure to select the TV's correct input source by pressing the SOURCE button on the remote control. • Reboot the connected device by unplugging and then reconnecting the device's power cable. |
| The remote control does not work. | <ul style="list-style-type: none"> • Replace the remote control batteries. Make sure the batteries are installed with their correct polarities (+/-) in the correct direction. • Clean the transmission window located on the top of the remote. • Try pointing the remote directly at the TV from 5~6 feet away. |
| The cable/set top box remote control does not turn the TV on or off, or adjust the volume. | <ul style="list-style-type: none"> • Program the Cable/Set top Box remote control to operate the TV. Refer to the Cable/Set top Box user manual for the SAMSUNG TV code. |

 This TFT LED panel uses a panel consisting of sub pixels which require sophisticated technology to produce. However, there may be a few bright or dark pixels on the screen. These pixels will have no impact on the performance of the product.

 You can keep your TV as optimum condition to upgrade the latest firmware on web site (samsung.com → Support → Downloads) by USB.

License



List of Features

Excellent Digital Interface & Networking: With a built-in HD digital tuner, nonsubscription HD broadcasts can be viewed without a cable box / STB (Set-Top-Box) satellite receiver.

- **My Contents**
Allows you to play music files, pictures, and movies saved on a USB device.
- **Anynet+(HDMI-CEC)**
Allows you to control all connected Samsung devices that support Anynet+ with your Samsung TV's remote.



Securing the TV to the Wall





Caution: Pulling, pushing, or climbing onto the TV may cause the TV to fall. In particular, ensure that your children do not hang over or destabilize the TV; doing so may cause the TV to tip over, resulting in serious injuries or death. Follow all safety precautions provided on the included Safety Flyer. For added stability, install the anti-fall device for safety purposes, as follows.

To avoid the TV from falling

1. Put the screws into the clamps and firmly fasten them onto the wall. Confirm that the screws have been firmly installed onto the wall.

-  You may need additional material such as an anchor depending on the type of wall.
-  Since the necessary clamps, screws, and string are not supplied, please purchase these additionally.

2. Remove the screws from the centre back of the TV, put the screws into the clamps, and then fasten the screws onto the TV again.

-  Screws may not be supplied with the product. In this case, please purchase the screws of the following specifications.
-  Screw Specifications

- For a 19 ~ 27 Inch LED TV: M4

3. Connect the clamps fixed onto the TV and the clamps fixed onto the wall with a strong string and then tie the string tightly.

NOTE

- Install the TV near to the wall so that it does not fall backwards.
- It is safe to connect the string so that the clamps fixed on the wall are equal to or lower than the clamps fixed on the TV.
- Untie the string before moving the TV.

4. Verify all connections are properly secured. Periodically check connections for any sign of fatigue for failure. If you have any doubt about the security of your connections, contact a professional installer.

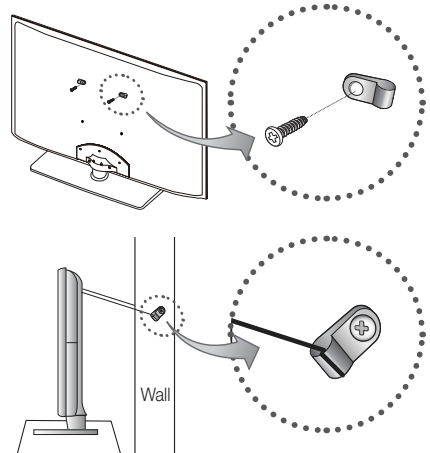

Storage and Maintenance

 If you remove the attached sticker on the TV screen, clean the residues and then watch TV.

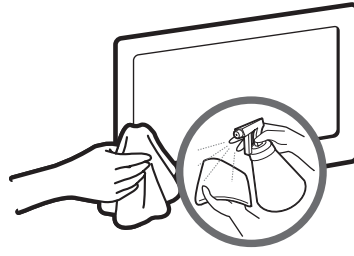
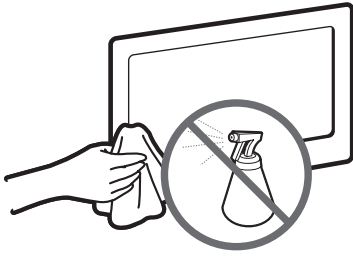

Do not spray water or a cleaning agent directly onto the product. Any liquid that goes into the product may cause a failure, fire, or electric shock.

Clean the product with a soft cloth dampened with a small amount of water.

Specifications

| | | |
|------------------------------|--|--|
| Display Resolution | 1920 x 1080 | |
| Environmental Considerations | Operating Temperature: 10°C to 40°C (50°F to 104°F) Operating Humidity: 10% to 80%, non-condensing Storage Temperature: -20°C to 45°C (-4°F to 113°F) Storage Humidity: 5% to 95%, non-condensing | |
| Model Name | UN22D5000NF / UN22D5010NF | UN27D5000NF |
| Screen Size (Diagonal) | 22" Class (21.5" measured diagonally) | 27" Class (26.9" measured diagonally) |
| Sound (Output) | 3 W X 2 | 5 W X 2 |
| Dimensions (WxDxH) | Body: 20.6 X 1.2 X 12.7 inches (522.0 X 29.9 X 323.1 (mm)) With stand: 20.6 X 5.7 X 14.8 inches (522.0 X 144.8 X 377.0 (mm)) | |
| Weight | Without Stand: 7.9 lbs (3.6kg) With Stand: 8.6 lbs (3.9kg) | |
| | Without Stand: 10.1 lbs (4.6kg) With Stand: 11.5 lbs (5.2kg) | |

 Design and specifications are subject to change without prior notice.

 This device is a Class B digital apparatus.

 For information about power supply, and more about power consumption, refer to the label attached to the product.

 Dispose unwanted electronics through an approved recycler. To find the nearest recycling location, go to our website: www.samsung.com/recyclingdirect or call, (877) 278-0799.

Dimensions

■ Front view / Side view

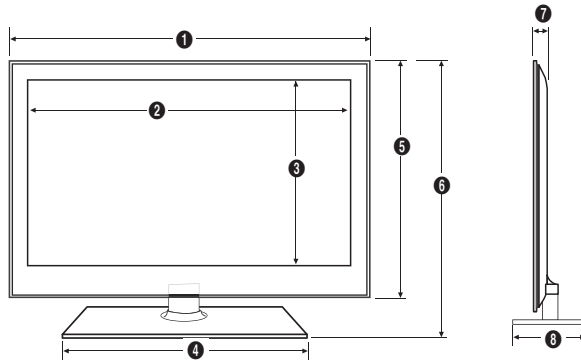

(Unit: inches)

| Model name | 1 | 2 | 3 | 4 | 5 | 6 | 7 | 8 |
|-------------|------|------|------|------|------|------|-----|-----|
| UN22D5000NF | 20.6 | 18.8 | 10.8 | 10.5 | 12.7 | 14.8 | 1.2 | 5.7 |
| UN22D5010NF | | | | | | | | |
| UN27D5000NF | 25.4 | 23.7 | 13.3 | 13.6 | 12.7 | 17.8 | 1.2 | 6.9 |

■ Jack panel detail / Rear view

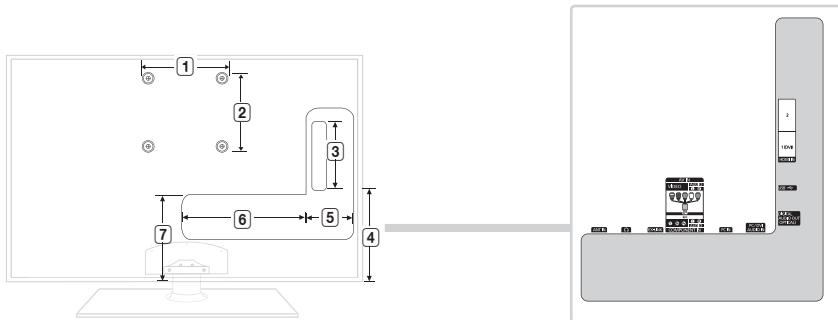

(Unit: inches)

| Model name | 1 | 2 | 3 | 4 | 5 | 6 | 7 |
|-------------|-----|-----|-----|-----|-----|-----|-----|
| UN22D5000NF | 3.0 | 3.0 | 3.9 | 5.2 | 2.8 | 7.4 | 4.7 |
| UN22D5010NF | | | | | | | |
| UN27D5000NF | 7.9 | 3.9 | 3.9 | 5.6 | 3.9 | 7.4 | 5.1 |

NOTE: All drawings are not necessarily to scale. Some dimensions are subject to change without prior notice. Refer to the dimensions prior to performing installation of your TV. Not responsible for typographical or printed errors.

© 2011 Samsung Electronics America, Inc