



Contact SAMSUNG WORLD WIDE

If you have any questions or comments relating to Samsung products, please contact the SAMSUNG customer care center.

Country	Customer Care Center ☎	Web Site	Address
CANADA	1-800-SAMSUNG (726-7864)	www.samsung.com/ca/ support (English) www.samsung.com/ca_fr/ support (French)	Samsung Electronics Canada Inc. 2050 Derry Road West, Mississauga, Ontario L5N 0B9 Canada
U.S.A	1-800-SAMSUNG (726-7864)	www.samsung.com/us/ support	Samsung Electronics America, Inc. 85 Challenger Road Ridgefield Park, NJ 07660



SERIES **7**  
7100  
7150

# LED TV user manual



Thank you for purchasing this Samsung product.  
To receive more complete service, please register  
your product at  
[www.samsung.com/register](http://www.samsung.com/register)  
Model \_\_\_\_\_ Serial No. \_\_\_\_\_

If you have any questions, please call us at 1-800-SAMSUNG (1-800-726-7864) for assistance.  
\* This Nanum Gothic Eco font is provided by NAVER.

© 2014 Samsung Electronics Co., Ltd. All rights reserved.



BN68-05934A-01

# Warning! Important Safety Instructions

(Please read the Safety Instructions before using your TV.)

## CAUTION

### RISK OF ELECTRIC SHOCK DO NOT OPEN

CAUTION: TO REDUCE THE RISK OF ELECTRIC SHOCK, DO NOT REMOVE COVER (OR BACK). THERE ARE NO USER SERVICEABLE PARTS INSIDE. REFER ALL SERVICING TO QUALIFIED PERSONNEL.



This symbol indicates that high voltage is present inside. It is dangerous to make any kind of contact with any internal part of this product.



This symbol indicates that important literature concerning operation and maintenance has been included with this product.

- The slots and openings in the cabinet and in the back or bottom are provided for necessary ventilation. To ensure reliable operation of this apparatus, and to protect it from overheating, these slots and openings must never be blocked or covered.
  - Do not place this apparatus in a confined space, such as a bookcase, or built-in cabinet, unless proper ventilation is provided.
  - Do not place this apparatus near or over a radiator or heat register, or where it is exposed to direct sunlight.
  - Do not place vessels (vases etc.) containing water on this apparatus, as this can result in a fire or electric shock.
- Do not expose this apparatus to rain or place it near water (near a bathtub, washbowl, kitchen sink, or laundry tub, in a wet basement, or near a swimming pool etc.). If this apparatus accidentally gets wet, unplug it and contact an authorized dealer immediately.
- This apparatus uses batteries. In your community, there might be environmental regulations that require you to dispose of these batteries properly. Please contact your local authorities for disposal or recycling information.
- Do not overload wall outlets, extension cords or adaptors beyond their capacity, since this can result in fire or electric shock.
- Power-supply cords should be placed so that they are not likely to be walked on or pinched by items placed upon or against them. Pay particular attention to cords at the plug end, at wall outlets, and the point where they exit from the appliance.
- To protect this apparatus from a lightning storm, or when it is left unattended and unused for long periods of time, unplug it from the wall outlet and disconnect the antenna or cable system. This will prevent damage to the set due to lightning and power line surges.
- Before connecting the AC power cord to the DC adaptor outlet, make sure the voltage designation of the DC adaptor corresponds to the local electrical supply.
- Never insert anything metallic into the open parts of this apparatus. Doing so may create a danger of electric shock.
- To avoid electric shock, never touch the inside of this apparatus. Only a qualified technician should open this apparatus.

- Make sure to plug the power cord in until it is firmly seated. When unplugging the power cord from a wall outlet, always pull on the power cord's plug. Never unplug by pulling on the power cord. Do not touch the power cord with wet hands.
- If this apparatus does not operate normally - in particular, if there are any unusual sounds or smells coming from it - unplug it immediately and contact an authorized dealer or service center.
- Be sure to pull the power plug out of the outlet if the TV is to remain unused or if you are to leave the house for an extended period of time (especially when children, elderly or disabled people will be left alone in the house).
  - Accumulated dust can cause an electric shock, an electric leakage or a fire by causing the power cord to generate sparks and heat or the insulation to deteriorate.
- Be sure to contact an authorized service center for information if you intend to install your TV in a location with heavy dust, high or low temperatures, high humidity, chemical substances, or where it will operate 24 hours a day such as in an airport, a train station, etc. Failing to do so may lead to serious damage to your TV.
- Use only a properly grounded plug and wall outlet.
  - An improper ground may cause electric shock or equipment damage. (Class I Equipment only.)
- To turn this apparatus off completely, you must disconnect it from the wall outlet. Consequently, the wall outlet and power plug must be readily accessible at all times.
- Do not allow children to hang onto the product.
- Store the accessories (battery, etc.) in a location safely out of the reach of children.
- Do not install the product in an unstable location such as a shaky self, a slanted floor, or a location exposed to vibration.
- Do not drop or strike the product. If the product is damaged, disconnect the power cord and contact a service center.
- To clean this apparatus, unplug the power cord from the wall outlet and wipe the product using a soft, dry cloth. Do not use any chemicals such as wax, benzene, alcohol, thinners, insecticide, air fresheners, lubricants, or detergent. These chemicals can damage the appearance of the TV or erase the printing on the product.
- Do not expose this apparatus to dripping or splashing.
- Do not dispose of batteries in a fire.
- Do not short-circuit, disassemble, or overheat the batteries.
- There is danger of an explosion if you replace the batteries used in the remote with the wrong type of battery. Replace only with the same or equivalent type.
- **WARNING - TO PREVENT THE SPREAD OF FIRE, KEEP CANDLES OR OTHER ITEMS WITH OPEN FLAMES AWAY FROM THIS PRODUCT AT ALL TIMES.**
- This product contains chemicals known to the State of California to cause cancer and reproductive toxicity.
- Use care when touching the TV after it has been on for some time. Some parts can be warm to the touch.



## Internet Security

Samsung takes a number of steps to protect its Internet-compatible Smart TVs against unauthorized incursions and hacking. For example, certain sensitive communications between the TV and the Internet servers are encrypted. In addition, the TV's operating system has adopted controls to prevent the installation of unauthorized applications.

Although we take steps to protect your SmartTV and information, no Internet-connected device or transmission is completely secure. We therefore encourage you to take additional steps to safeguard your TV, secure your Internet connection, and minimize the risk of unauthorized access. These steps are listed below:

- When Samsung releases software updates to improve the security on your TV, you should promptly install these updates. To automatically receive these updates, turn on **"Auto Update"** in the TV's menu (**Support > Software Update > Auto Update**). When an update is available, a popup message appears on the TV screen. Accept the software download and update by selecting YES when prompted. Take steps to secure your wireless router and network. Your router's manual should provide additional details about how to implement the following measures:
  - Secure your wireless router's management settings with a unique password to prevent unauthorized changes to security related settings.
  - Implement standard encryption (e.g., WPA2 encryption) on your wireless router to secure your wireless network signal.
  - Secure access to your wireless network with a hard-to-guess password.
  - Confirm your router's firewall setting is enabled (if so equipped).
  - Make sure all your Internet connected devices are behind your network's firewall.
  - If your router or modem has a standby mode button, use it to disconnect your home network from the Internet when it is not in use.
- Use strong passwords for all your Internet accounts (Netflix, Facebook, Skype, etc.). If your TV has a camera, recess the camera into the TV's bezel when it is not in use. Recessing the camera makes it inoperative.
- If any unexpected messages appear on your TV screen requesting permission to link a device or enable a remote session, do NOT accept.
- Do not visit suspicious web sites and do not install any suspicious programs. We recommend users install only those authorized apps provided by Samsung through Samsung Smart Hub.

Figures and illustrations in this User Manual are provided for reference only and may differ from the actual product appearance. Product design and specifications may change without notice.

## Features of your new TV

### 3D

This new feature lets you view 3D content.

### SMART HUB

Your TV features Smart Hub, a multi-purpose entertainment and family center. With Smart Hub, you can surf the web, download applications, and stay in touch with family and friends through social networking services. In addition, you can view or play photo, video, and music files stored on external storage devices.

Press the  button to launch Smart Hub. Choose a service using the icons displayed in the top part of the screen.

Smart Hub services and functionality include:

**Games:** You can view all game apps provided by Smart Hub and download and play games you select.

**SAMSUNG APPS:** Samsung Apps offers an extensive collection of free and for-pay news, sports, weather, and gaming content you can download directly to and enjoy on your TV.

**On TV:** View a listing of programs that are currently airing or are scheduled to air. Select a program to watch.

**MOVIES & TV SHOWS:** Purchase and stream movies and series directly from the Internet.

**MULTIMEDIA:** Play back photo, video, and music files from an external storage device.

### Anynet+ (HDMI-CEC)

Lets you to control all connected Samsung devices that support Anynet+ with your Samsung TV's remote.

### e-Manual

Provides a detailed, on-screen user's manual built into your TV (page 21).

### SMART Interaction

Access and control menu options and functions using motions. To use Smart Interaction, connect the SMART TV camera (sold separately) to the TV.

### Device Manager

Use the TV features with a USB or Bluetooth keyboard and mouse.

### Screen Mirroring

Displays mobile device screens on the TV using a wireless connection.

# Contents

## 01. Turning on the TV and Cabling

- 7 Turning on and Controlling the TV
- 7 Arrange the cables using the Cable Holder

## 02. Using the Remote Control

- 8 Using the Remote Control

## 03. Using the Samsung Smart Control

- 10 Buttons and Functions
- 15 Switching Between Video Sources
- 15 Using the Remote Control to Control External Devices
- 15 Connecting the IR Extender Cable
- 16 Setting Up the Universal Remote Control

## 04. Smart Hub

## 05. Using the e-Manual

- 21 Launching the e-Manual
- 21 Additional e-Manual Features
- 22 Updating the e-Manual to the Latest Version

## 06. Troubleshooting and Maintenance

- 23 Troubleshooting
- 25 Network Troubleshooting
- 28 Eco Sensor and Screen Brightness
- 29 Getting Remote Support
- 29 Caring for the TV

## 07. Specifications, wall mounting, and other information

- 30 Specifications
- 32 Dimensions
- 33 Licenses
- 34 Mounting the TV on a Wall Using the Wall Mount Kit (Optional)
- 35 Providing Proper Ventilation for Your TV
- 36 Securing the TV to the Wall
- 37 Warranty Information
- 38 SAMSUNG BRAND PRODUCTS

# 01. Turning on the TV and Cabling

## Turning on and Controlling the TV

You can turn on the TV using the Samsung Smart Control or the TV's Controller, a small joystick-like button on the back of the TV in its lower-left corner. You can also use the TV's Controller to operate the TV without the Samsung Smart Control.

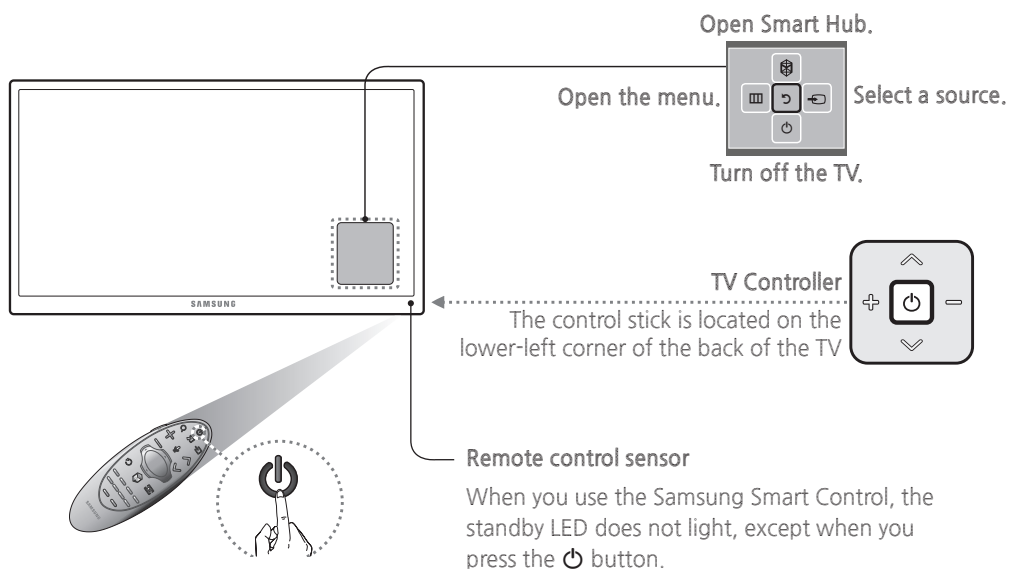

## Arrange the cables using the Cable Holder

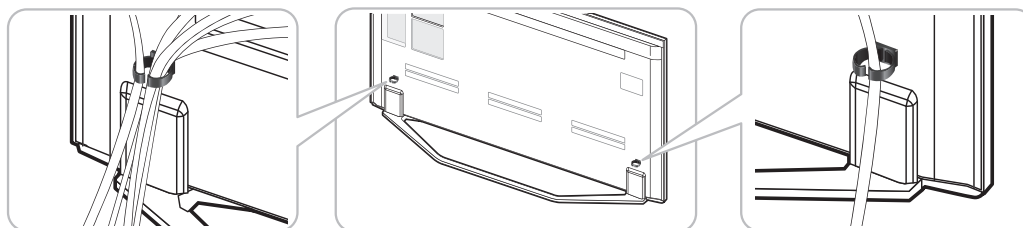

Make sure you have the correct cable before plugging it in. Illustrations of common plugs and ports are shown below.

	Cable Plugs	Ports	
HDMI			<p><b>Warning</b> Do not plug cables in upside down. Be sure to check the orientation of the plug before plugging it in.</p>
USB			
Optical			

# 02. Using the Remote Control

## Using the Remote Control

- The standard remote control is provided for ease of use.

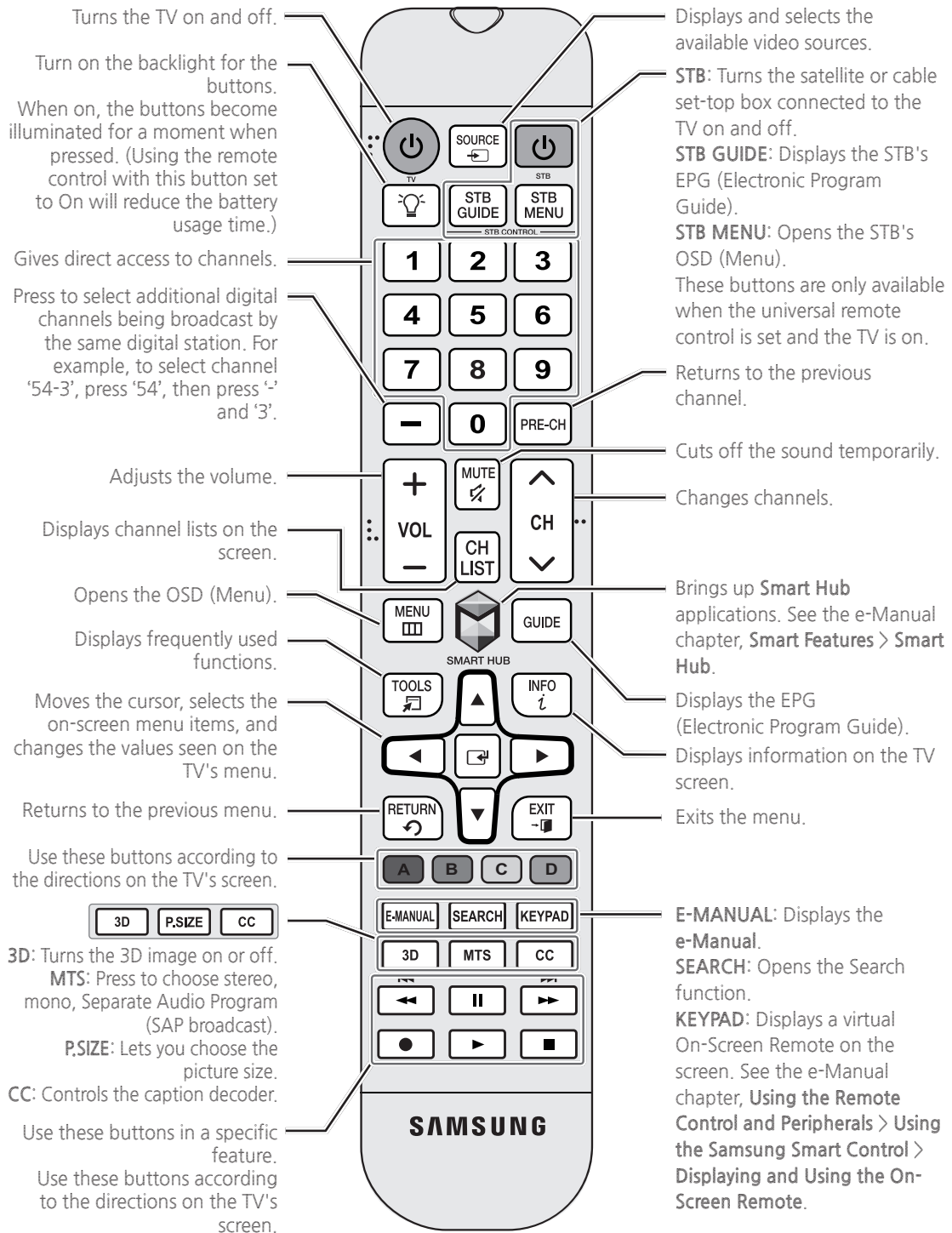



## Installing Batteries into the Remote Control

Match the polarity of the batteries to the symbols in the battery compartment.

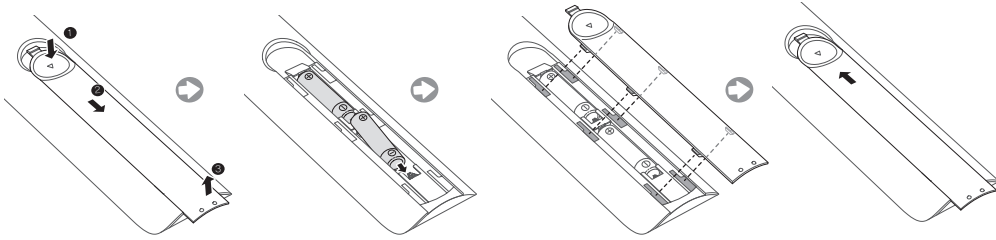

### NOTE

- Use the remote control within 23 feet of the TV.
- Bright light may affect the performance of the remote control. Avoid using near bright fluorescent lights or neon signs.
- The color and shape may vary depending on the model.

# 03. Using the Samsung Smart Control

## Buttons and Functions

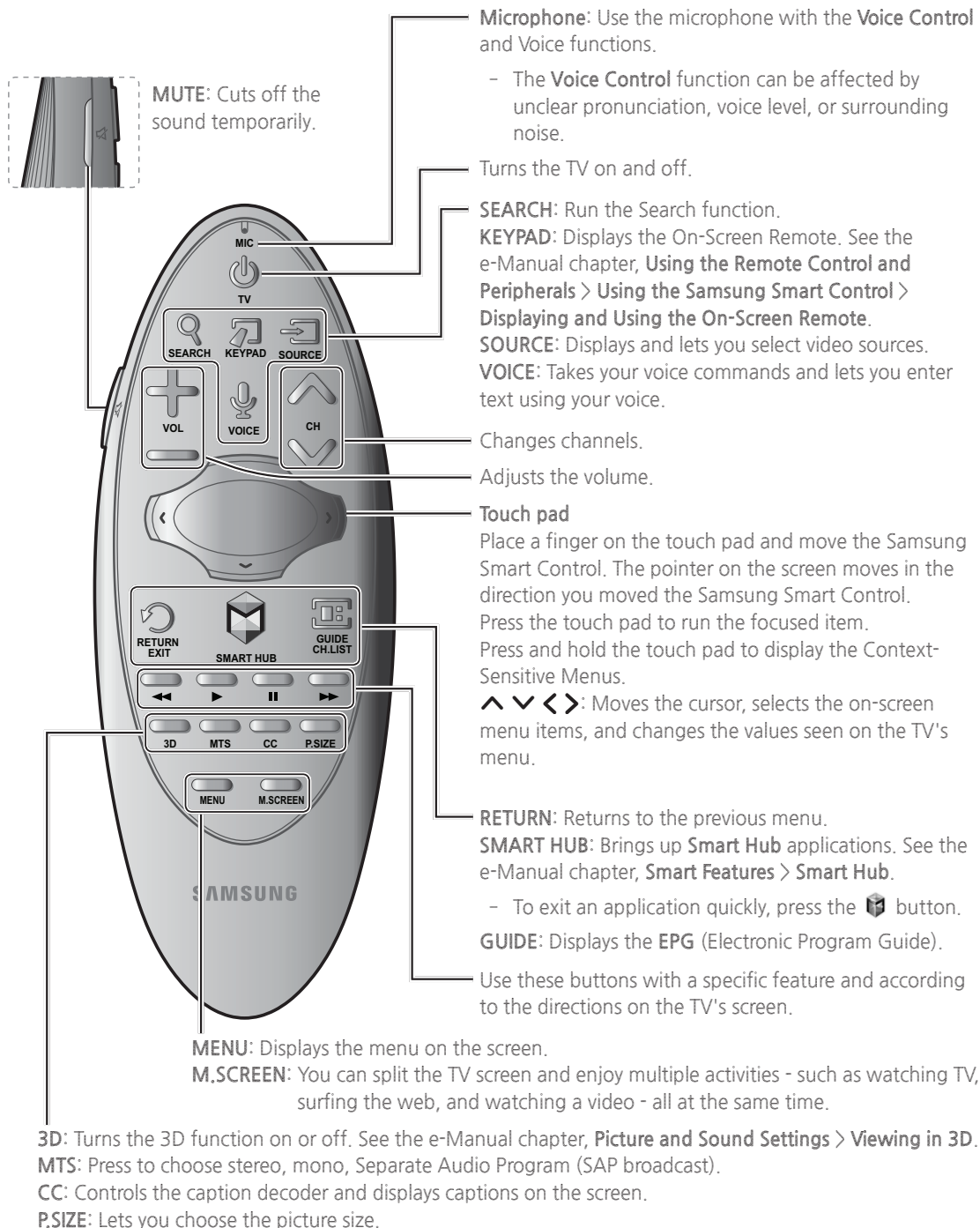

## Installing Batteries into the Samsung Smart Control

To use the Samsung Smart Control, insert the batteries into the device referring to the figure below.

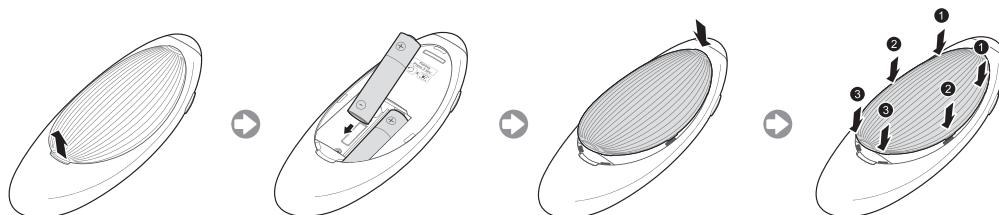

1. Gently pull on the battery cover's notch, and then remove the cover completely once it comes loose.
2. Insert 2 AA alkaline batteries, making sure to align the positive and negative polarities correctly.
3. Place the battery cover on the remote control and insert the top part of the cover into the remote control.
4. Press the catches on both sides of the battery cover in the order shown by the figure so that the cover is completely attached to the remote control.

## Using the Samsung Smart Control Motion Function to Operate the TV

The Samsung Smart Control has a motion sensor (gyro sensor) that lets you control the TV easily by moving the Samsung Smart Control and using it much like a cordless mouse.

Place a finger on the Samsung Smart Control's touch pad, and then move the Samsung Smart Control. A pointer appears on the screen. Move the Samsung Smart Control, and the pointer moves on the screen in the direction you moved the Samsung Smart Control and the same distance. Highlight an item on the screen with the pointer, and then press the touch pad to select it.

You can also move the Samsung Smart Control in the same fashion to scroll scrollable screens up and down.

- If you stop using the Motion Function, even momentarily, put your finger on the touch pad again, and then move the Samsung Smart Control to re-start the function.
- If **Voice Guide** is set to **On**, the Samsung Smart Control's motion sensor does not work. For the motion sensor in the Samsung Smart Control to work, you must set **Voice Guide** to **Off**.

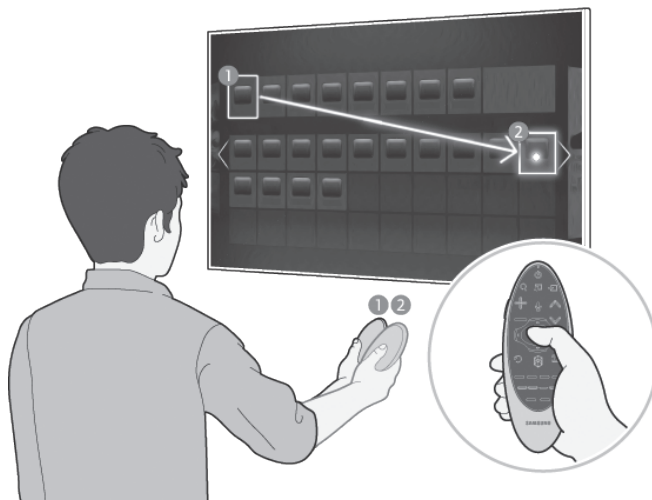

## Using the Touch Pad and the Directional Buttons

- In the TV's menu, navigate to **Support** > **Smart Control Tutorial** to view a tutorial that shows how to use the touch pad.
- If the touch pad's sensitivity is too high or low, navigate to the **System** > **Smart Control Settings** menu, and then select the **Touch Sensitivity** option to change the touch pad sensitivity.

### Moving the Focus or Pointer

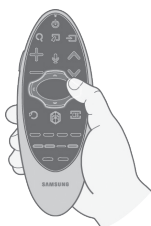

Press the directional buttons (up, down, left, and right) to move the focus, pointer, or cursor in the direction you want.

### Entering the Menu / Selecting an Item



To enter a menu or select an item, highlight the item or the menu title, or move the pointer over it, and then press the touch pad.

### Displaying Context-sensitive Menus in Smart Hub



In Smart Hub, highlight an item, and then press and hold the touch pad. The context-sensitive menu for the item pops up.

- The context-sensitive menu may vary depending on the item you selected.

### Changing the Smart Hub Panel



On a Smart Hub panel, drag left or right on the touch pad. The previous or next Smart Hub panel appears.

### Scrolling on the Web Browser



When you are using the web browser, drag up or down on the touch pad to scroll the web screen.

## Reconnecting the Samsung Smart Control to the TV

If the Samsung Smart Control stops operating or works abnormally, try replacing the batteries. If the problem persists, pair the Samsung Smart Control and TV again.

1. Move to within a foot of the TV, and then aim the Samsung Smart Control at the TV's remote control sensor.

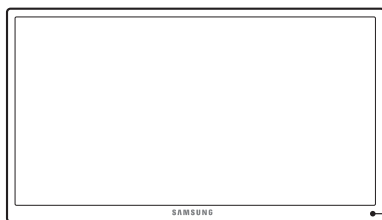

Remote Control Sensor

2. Press the **RETURN** button and **GUIDE** button simultaneously for 3 seconds.
3. The connecting icon appears on the screen. A few moments later, the connected icon appears. The Samsung Smart Control is paired to the TV.

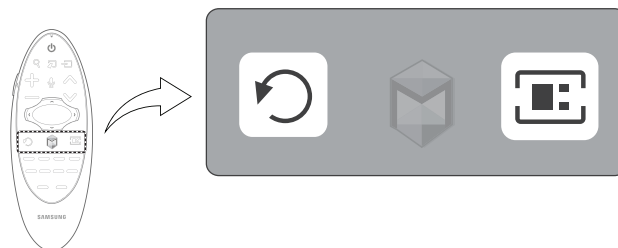

## The Low Battery Alarm Window

If the Samsung Smart Control's batteries become low, the Low Battery Alarm appears on the screen. When the Alarm appears, replace the batteries. We recommend using alkaline batteries for longer operating life.





<Low battery Alarm Icon>

## Displaying and Using the On-Screen Remote

Press the **KEYPAD** button on the Samsung Smart Control to display the On-Screen Remote on the TV's screen. Use the On-Screen Remote to enter numbers, control content playback, and use the features and functions of the TV, just like a real remote. Use the directional buttons on the Samsung Smart Control to move the cursor on the On-Screen Remote. Press the touch pad on the Samsung Smart Control to select.

- The On-Screen Remote buttons may vary depending on the TV features or functions you are using.

Button	Description
1 2 3 4 5 6 7 8 9 - 0 	Lets you switch channels by entering channel numbers directly. Select <b>Pre-CH</b> to return to the previous channel.
	Controls the playback of video, photo, or music files from all sources, and the playback of media content on external devices (for example, a Blu-ray player).
<b>A, B, C, D</b>	Use these colored buttons to access additional options specific to the feature in use.
<b>TOOLS</b>	Press to display the Tools menu while you are watching TV. The Tools menu gives you easy access to frequently used functions. The functions listed are context-sensitive and vary depending on how you are currently using the TV.
<b>INFO</b>	Shows information about the current digital broadcast program or content.
<b>MENU</b>	Displays the TV's menu on the screen.
<b>Speaker Settings</b>	Lets you select the speakers which will play the TV's audio. You must connect a home theater or amplifier with external speakers to the TV to use this function.
<b>PIP</b>	Lets you display video from an external device or computer on the main screen and a TV broadcast in a picture-in-picture window.
<b>Multi-Link Screen</b>	Lets you split the TV screen and use multiple functions - such as watching TV, surfing the web, and playing a video - at the same time.
<b>CC</b>	Select to turn subtitles on or off.
<b>P.Size</b>	Changes the picture size.
<b>SLEEP</b>	This function automatically shuts off the TV after a preset period of time.
<b>P.Mode</b>	Lets you select the Picture Mode.
<b>Web Browser</b>	Launches the Web Browser.
<b>e-Manual</b>	Opens the e-manual.
<b>Sign In</b>	Select to log in to or out of your Samsung account.
	<p><b>Move to the right / Move to the left:</b> Moves the Onscreen Remote on the screen.</p> <p><b>Large size / Normal size:</b> Resizes the Onscreen Remote on the screen.</p> <ul style="list-style-type: none"> <li>- Alternatively, navigate to the <b>System &gt; Smart Control Settings</b> menu and select and set the <b>Onscreen Remote Size</b> option.</li> </ul> <p><b>Touch Sensitivity:</b> Lets you change the touch pad sensitivity.</p> <ul style="list-style-type: none"> <li>- Alternatively, navigate to the <b>System &gt; Smart Control Settings</b> menu and select and set the <b>Touch Sensitivity</b> option.</li> </ul> <p><b>Universal Remote Setup:</b> Displays the Universal Remote Setup screen.</p> <p><b>Cancel:</b> Select to close a pop up menu.</p>

## Switching Between Video Sources

Press the **SOURCE** button to switch between external devices connected to the TV. For example, to switch to a game console connected to the second HDMI connector, press the **SOURCE** button. The Source List appears across the top of the screen. From the **Source** list, select **HDMI2**.

- The connector names may vary depending on the product.

## Using the Remote Control to Control External Devices

### MENU > System > Universal Remote Setup

The universal remote control feature lets you control cable boxes, Blu-ray players, home theaters, and other third-party external devices connected to the TV using the TV's remote control. For each external device you want to control, you must run the universal remote set up process. The first step in the process is connecting the IR extender cable (included) to the TV and positioning the transmitter end of the cable in front of the device you want to control.

- You can also use the Anynet+ (HDMI-CEC) function to operate external Samsung devices with your TV's remote control without any additional setup.

## Connecting the IR Extender Cable

- The color and design of the IR extender cable may vary depending on the model.

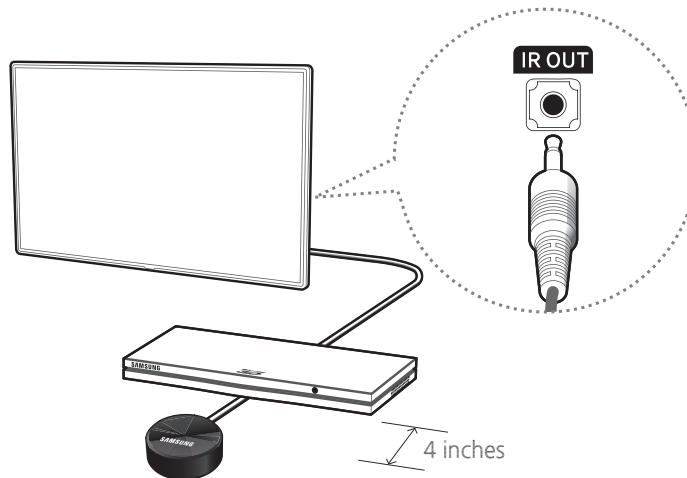

To begin the universal remote set up process, connect the IR extender cable (included) to the TV's IR output connector as shown in the diagram, and then position the transmitter end within 4 inches (10 cm) of the external device's remote control sensor, pointing in the direction of the sensor.

**There can be no obstacles between the transmitter end of the IR extender cable and the external device. Any obstacles will interfere with the transmission of the remote control signals.**

## Setting Up the Universal Remote Control

- If you want to control a set-top-box, you need to have your zip code and your cable provider's name and location on hand before you begin. If you want to control a Blu-ray player or home theater, you need the manufacturer's name and model number.
1. Turn on the external device you want to control with the universal remote function.
  2. Press the **SOURCE** button on your remote to bring up the **Source** screen.
  3. Select the **Universal Remote Setup** icon.
    - You can also start Universal Remote Setup through the TV's menu. Navigate to **System > Universal Remote Setup**.
  4. The TV checks if the IR extender cable is connected. If it confirms the connection, press the touch pad.
  5. Select the type of device you want to control - set-top-box, Blu-ray player, or home theater.
  6. Follow the directions on the screen to complete the set up and register the device. The directions will be different, depending on the device you want to control.
  7. Once set up is complete and you have confirmed that you can use the TV remote to control the device, disconnect the IR extender cable from the TV and set it aside. You can now control the device directly with your remote.

## Controlling an External Device with the TV Remote

During the universal remote set up process, the TV registers the connector (source) the external device is connected to. To control a registered external device with your TV's remote, select the external device on the Source List.

1. Press the **SOURCE** button on your remote.
2. Select the source the device is connected to (HDMI1, HDMI2, etc.)
3. Control the device with the remote. For example, if the device is a set-top-box, press the channel buttons on the remote to change the channel.

For information on additional functions, see "Controlling External Devices with the TV Remote - Using the Universal Remote" in the e-Manual.



## 04. Smart Hub

Smart Hub is the control center of the TV. Through Smart Hub you can view TV program schedules and select shows to watch, download and install apps and games, select and stream movies and TV shows, and playback photo, video, and music files located on Blu-ray players, USB devices, smart phones and tablets, your computer, and the Internet.

Smart Hub has five main panels: **Games**, **SAMSUNG APPS**, **On TV**, **MOVIES & TV SHOWS**, and **MULTIMEDIA**.

To move from panel to panel, select one of the icons at the top of the screen. You can also swipe left or right across the touch pad to display the previous or next panel. Each panel gives you access to additional screens. To open the additional screens, select items on the panel or select an icon or hotspot on the screen.

- The TV must be connected to the Internet to access Smart Hub.

### Games Panel

The **Games** panel displays games you can download to and play on your TV. You can also update or delete downloaded games. The **Games** panel has two sub-panels: **All Games** and **My Page**. **All Games** displays all the games available through Smart Hub. **My Page** displays the games you have downloaded. Most games listed on the **Games** panel are free, while some require a fee. To download a for-pay game, you must have a Samsung Account with a registered credit card.

### Basic Games Panel Functions

In the **My Page** or **All Games** panel, move the focus to a game, and then press and hold the touch pad. An Options drop down list appears with the following functions.

- **Download/Remove:** Downloads games to the TV or removes games from the TV.
- **View detail:** Displays detailed information about the selected game.

### Quickly Downloading and Installing a Game

Select a game, and then press and hold the touch pad. When the Options drop down list appears, select **Download** from the list. If the game is free, the game you selected is installed on the TV. If the game is not free, follow the directions on the screen to pay for and download the game.

### SAMSUNG APPS Panel

The **SAMSUNG APPS** panel displays a variety of free and for pay news, sports, weather, and gaming apps.

The Samsung Apps panel has a number of sub-panels including **Most Popular**, **What's new**, and **Categories**. Default apps install automatically when Smart Hub is first launched. The default apps may differ depending on your region. Most apps listed on the **SAMSUNG APPS** panel are free, but some apps require a fee. To download these, you must have a Samsung Account with a registered credit card.

## SAMSUNG APPS Panel Functions

Move the focus to an app, and then press and hold the touch pad. An Options drop down list appears with the following functions.

- **Move:** Relocates an app on the screen.
- **Delete:** Removes a selected app from your TV.
- **Multi Delete:** Removes multiple apps from the TV.
- **View Details:** Displays detailed information about a selected app.
- **Change View:** Changes how the apps are sorted on the screen, by Custom view or Most Played.
- **Lock/Unlock:** Locks or unlocks apps. Locked apps cannot be accessed.
- **Update Apps:** Displays a list of apps that have updates available. You can select which apps to update.

The **SAMSUNG APPS** Panel functions are context-sensitive. The functions that appear may differ depending on the app you select.

## Downloading and Installing an App

1. On the **SAMSUNG APPS** panel, select **Most Popular**, **What's new**, or **Categories**.
2. Move the focus to an app, and then press and hold the touch pad. When the Options drop down list appears, select **Download** from the list. If the app is free, the app you selected is installed on the TV. If the app is not free, follow the directions on the screen to pay for and download the app.

## On TV Panel

**On TV** displays your current program live in a small window, a list of recommended programs currently on other channels, and a list of recommended programs that will air later. Use these lists to change the channel, view more information about recommended programs running later, including how much time is left until they air. You can also set up a **Schedule Viewing** of a program that hasn't aired yet.

To view a program recommended by **On TV**, select the image.

The **On TV** panel has the following main subpanels:

- **Guide:** Displays the program schedule of each digital channel. You can check the program schedule and set up a **Schedule Viewing**.
- **Timeline View:** Displays program recommendations for different times of the day.
- **Trending:** Displays what is the most trendy or popular content on Twitter, You can set up a **Schedule Viewing** to view.

## On TV Panel Functions

Move the focus to a program, and then press and hold the touch pad. An **Options** drop down list appears with the following functions.

- **View details:** Displays detailed information about the selected program.
- **Reserving:** Sets up a **Schedule** for the selected program.

## MOVIES & TV SHOWS Panel

Buy or rent movies and TV shows online and stream them to your TV using apps downloaded via Smart Hub. This is called Video on Demand (VOD). The **MOVIES & TV SHOWS** screen displays recommended movies and TV shows and displays multiple VOD content sources so you can browse and watch all more easily.

The **MOVIES & TV SHOWS** panel has the following main subpanels:

- **Favorites:** View the movies and TV programs registered as Favorites.
- **Featured:** View movies or TV programs grouped according to various themes, such as movies with a specific actor or an actor who acted in a TV series, etc.
- **Movies:** View movies by release date, popularity, or genre.
- **TV Shows:** Search TV shows by air date, popularity, or genre.
- **Trailers:** View movie trailers for upcoming movies.
- **Trending:** View movies and TV programs that are the most trendy or popular on Twitter.

### Basic MOVIES & TV SHOWS Panel Functions

Move the focus to a movie or TV program, and then press and hold the touch pad. An Options drop down list appears with the following functions.

- **Play Content Now:** Displays the names of one or more content providers. Select a content provider to play the selected movie or TV program immediately. If the app for the content provider you selected is not installed on the TV, a pop-up window appears. In the pop-up window, select either to display the app's information page or to install the app immediately. Note that you can also install the app from the app's information page.
- **Add to/Remove from Favorites:** Add the selected content to or delete it from Favorites.

## MULTIMEDIA

The **MULTIMEDIA** Panel lets you play media content saved on USB devices, smartphones, cameras, computers, or in storage services. The **MULTIMEDIA** Panel has three main subpanels: **USB Drive**, **Network Device**, and **Storage Service**. USB Drive displays USB devices connected to the TV. Network Device displays devices connected to your TV through your home network (a computer, a smart phone, etc.). Storage Service displays services such as Dropbox and SkyDrive linked via your Samsung account to the TV.

## Allowing Connections with a Computer or Mobile Device

To play multimedia content located on a computer or mobile device on the TV, you need to:

1. Establish the connection to the computer or device.
2. Allow the connection with the computer/mobile device on the TV.

For information about establishing connections, see the “**Connecting to a Computer**” and “**Connecting to a Mobile Device**” sections of the e-Manual.

To allow a connection with a computer or mobile device, follow these steps:

1. Press the  button on the Samsung Smart Control, and then select **Network Device** in the **MULTIMEDIA** panel. The devices connected to the TV are listed.
2. Select **Options > Multimedia device settings**. The devices connected to the TV are listed.
  - Alternatively, select **Multimedia Device Settings** from the **Network** menu to see the list of the devices connected to the TV.
3. Allow the connection with the device you want to connect to the TV.

## Playing Content

1. If you want to play content located in a Storage Service, navigate to the **Smart Hub > Samsung Account** menu, and then select **Log In** to sign in to your Samsung account. If you want to play content located on a device connected to the TV using Samsung Link, go to Step 2 below.
2. Press the  button, and then select **Network Device** or **Storage Service** in the **MULTIMEDIA** panel. The devices or storage services connected to the TV appear.
3. Select a device or storage service. The folders and files shared by the selected device or storage service appear.
4. Select the media content you want to play from the list.

# 05. Using the e-Manual

## Launching the e-Manual

### MENU > Support > e-Manual

The embedded e-manual contains information about your TV's key features.

- Alternatively, you can download a copy of the e-manual from Samsung's website, and read it on your computer or print it out.
  - Words in yellow (e.g., **Picture Mode**) indicate a menu item and bold words in white (e.g., **Smart Hub**) indicate remote control buttons.
  - Arrows are used to indicate the menu path. (Example: **MENU > Picture > Picture Mode**)
1. On the Samsung Smart Control, press the **KEYPAD** button, and then select **e-Manual** on the On-Screen Remote. You can also select **Support > e-Manual** in the TV's menu.
  2. Select a category from the left side of the screen. Once a selection has been made, the contents of the selected category appear on the right side of the screen.
  3. Select an item from the list. This opens the e-manual on the corresponding page.

### If a description doesn't fit on a single screen...

- Position the focus on the page to display  /  on the screen. Press the  or  buttons to scroll the page up and down.

## Additional e-Manual Features

### Loading Pages using Keywords

Select **Search** to bring up the search screen. Enter a search term, and then select **Done**. Select an item from the search results to load the corresponding page.

## Loading Pages from the Index Page

Select **Index** to bring up the index screen. Select a keyword from the list to navigate to the relevant page.

## Using History to Load Previously Read Pages

Select **Opened page**. A list of previously read pages is shown. Select a page. The e-Manual jumps to the selected page.

## Accessing the Menu from the e-Manual

Select  (Try Now) from the right side of a feature-description page to access the corresponding menu item and try out the feature right away. If you want to read the e-Manual entry on a specific screen menu feature:

- On the Samsung Smart Control, press the **KEYPAD** button, and then select e-Manual on the On-Screen Remote to load the corresponding e-Manual page.
- The e-Manual cannot be accessed from some menu screens.

## Loading Reference Pages

Select  (Link) from the right side of a feature-description page to access the corresponding reference page.

## Updating the e-Manual to the Latest Version

You can update the e-Manual in the same way you update apps.

1. Press the  button, and then highlight the **e-Manual** item in the **SAMSUNG APPS** screen.
2. On the Samsung Smart Control, press and hold the touch pad. A pop-up menu appears.
3. Select **Update Apps** from the pop-up menu. A pop-up window appears.
  - **Update Apps** appears on the screen only when an update is available.
4. Select e-Manual in the popup window, and then select **Update**.

## Configuring Auto Update

**MENU** > **Smart Hub** > **Apps Settings**

To update the e-manual automatically, navigate to the **Smart Hub** > **Apps Settings** menu and set the **Auto Update** option to **On**. The e-manual is updated automatically when an update becomes available.

# 06. Troubleshooting and Maintenance

## Troubleshooting

If the TV seems to have a problem, first review this list of possible problems and solutions. Also, review the Troubleshooting Section in the e-Manual. If none of the troubleshooting tips apply, visit [www.samsung.com/support](http://www.samsung.com/support) or call Samsung Customer Service at 1-800-SAMSUNG (1-800-726-7864).

Issues	Solutions and Explanations
Flickering and Dimming	Try disabling some of the TV's energy efficiency features. Disable <b>Energy Saving</b> (System > Eco Solution > Eco Sensor) and/or <b>Energy Saving</b> (System > Eco Solution > Energy Saving) and check again.
Screen Color is Not Correct	Run a Self Diagnosis Picture Test (Support > Self Diagnosis > Picture Test). If the picture problem is caused by the TV, the problem should be visible in the Picture Test. If the problem is not visible, next confirm that the TV's video input ports are connected to the correct external video device output ports and that none of the connections are loose. Finally, if possible, test your external video devices by connecting them to another TV.
Screen Brightness	Adjust the following settings: Navigate to <b>Picture</b> and adjust <b>Backlight</b> , <b>Contrast</b> , <b>Brightness</b> , <b>Sharpness</b> , <b>Color</b> , <b>Tint (G/R)</b> and other picture quality adjustment settings.
Blurred Images	Turn on <b>Auto Motion Plus</b> (Picture > Picture Options > Auto Motion Plus).
Unwanted Powering Off	Check if <b>Sleep Timer</b> (System > Time > Sleep Timer) has been enabled. <b>Sleep Timer</b> automatically turns off the TV after an amount of time that you select. If the <b>Sleep Timer</b> has not been enabled, see if <b>No Signal Power Off</b> (System > Eco Solution > No Signal Power Off) or <b>Auto Power Off</b> (System > Eco Solution > Auto Power Off) has been enabled. <b>No Signal Power Off</b> turns off the TV if no signal has been received by the TV for a specified period time. <b>Auto Power Off</b> turns off the TV if there has been no user input in four hours.
Trouble Powering On	Confirm that the power cord is connected and that the remote has live batteries and is functioning correctly. If the power cord is connected properly and the remote control is operating normally, there might be a problem with the antenna cable connection or the cable/satellite box might not be turned on. Check the antenna connection or turn on the cable/satellite box.
Stand Assembly	If you have any trouble assembling the stand, review the stand assembly instruction in the Quick Start Guide.
Cannot Find a Channel	Re-run <b>Setup</b> (Go to MENU > System > Setup) or run <b>Auto Program</b> . (Go to MENU > Broadcasting > Auto Program).

- For detailed troubleshooting information, watch the troubleshooting videos at [www.samsung.com/spsn](http://www.samsung.com/spsn).

Issues	Solutions and Explanations
The TV won't turn on.	<p>Make sure the AC power cord is securely plugged in to the wall outlet and the TV.</p> <p>Make sure the wall outlet is working.</p> <p>Try pressing the  button on the TV to make sure the problem is not the remote. If the TV turns on, refer to "Remote control does not work" below.</p>
There is no picture/video.	<p>Check the cable connections. Remove and reconnect all cables connected to the TV and external devices.</p> <p>Set the video outputs of your external devices (Cable/Sat Box, DVD, Blu-ray etc) to match the TV's input connections. For example, if an external device's output is HDMI, it should be connected to an HDMI input on the TV.</p> <p>Make sure your connected devices are powered on.</p> <p>Be sure to select the correct input source.</p> <p>Reboot the connected device by unplugging it, and then reconnecting the device's power cable.</p>
The remote control does not work.	<p>Replace the remote control batteries. Make sure the batteries are installed with their poles (+/-) in the correct direction.</p> <p>Clean the sensor's transmission window on the remote.</p> <p>Try pointing the remote directly at the TV from 5~6 feet away.</p>
The cable/set top box remote control doesn't turn the TV on or off or adjust the volume.	<p>Program the Cable/Set remote control to operate the TV. Refer to the Cable/Set-Top-Box user manual for the SAMSUNG TV code.</p>

- This TFT LED panel is made up of sub pixels which require sophisticated technology to produce. There may be, however, a few bright or dark pixels on the screen. These pixels will have no impact on the performance of the product.
- To keep your TV in optimum condition, upgrade to the latest software. Use the Update Now or Auto Update functions on the TV's menu (Screen **MENU** > **Support** > **Software Update** > **Update now** or Screen **MENU** > **Support** > **Software Update** > **Auto Update**).



# Network Troubleshooting

## How to Improve Your Wireless Signal

Position your wireless router, modem router, or access point in a central location.

The best place for a Wi-Fi router is in the center of your home.

If that is not possible, move it as close to the center of your home as possible. Avoid putting it in a corner.

### Single Story

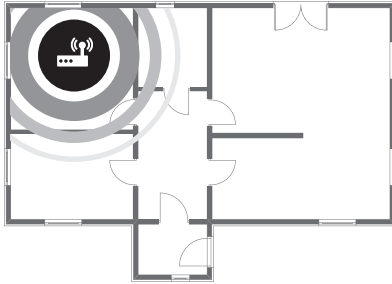

Bad Router Position

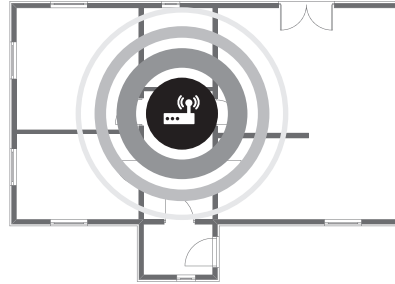

Good Router Position

### Multi Story

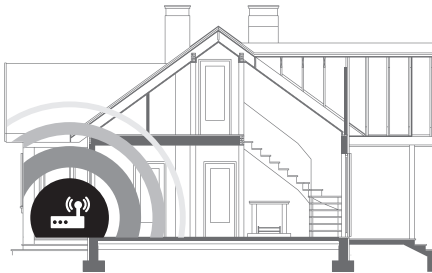

Bad Router Position

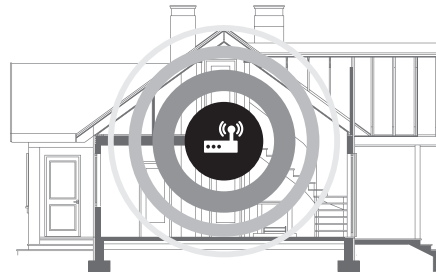

Good Router Position

## Adding a wireless repeater

A wireless repeater is a device which extends your wireless network's range without requiring you to add any wiring. All you need to do is place the repeater halfway between your wireless router and your TV, and you will get an instant boost in your wireless signal strength.

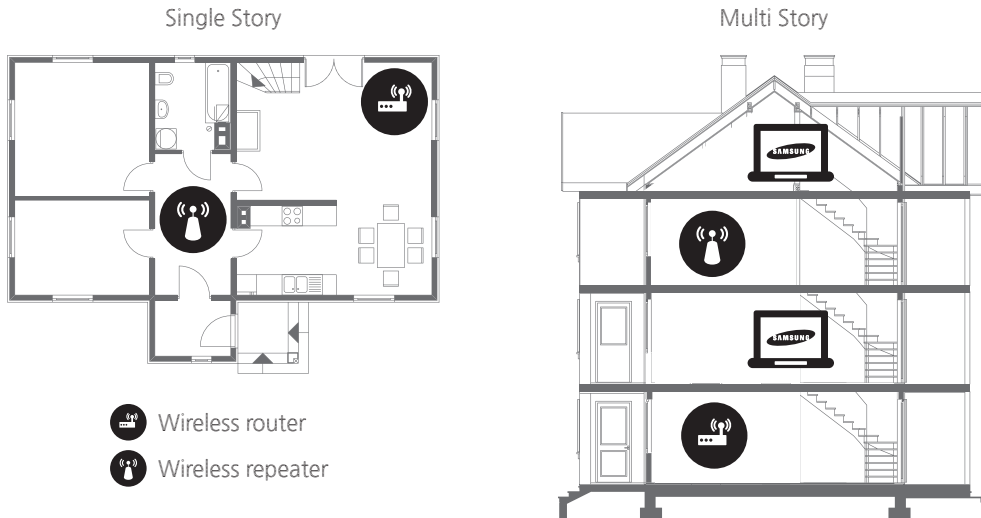

## Do not locate the router on the floor and keep it away from walls and metal objects

Avoid placing the router near objects such as metal filing cabinets. Metal objects, walls, and floors will interfere with your router's wireless signal. The closer your router is to these obstructions, the more severe the interference, and the weaker the signal.

## Reduce wireless interference

The most common wireless technology, 802.11g (wireless-G), operates at a frequency of 2.4GHz. Many cordless phones, microwave ovens, baby monitors, garage doors, and other wireless devices also use this frequency. Reduce interference by avoiding wireless devices that use the 2.4GHz frequency and use devices that communicate via the 5.0 GHz frequency instead.

## Replace your router's antenna

If you must place your router in the corner, consider replacing your standard antenna with a Hi-Gain wireless antenna.

High gain antennas can be attached to most wireless routers. They boost the signal strength and aim the signal in one direction.

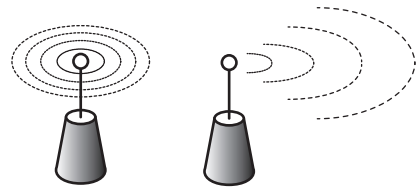

## Intermittent Wi-Fi

- Check the distance between the Modem/Router and the TV. The distance should not exceed 50ft (15.2 m).
- Verify that there are no obstacles between your TV and the Modem/Router. (Appliances, cordless phones, stone walls/fireplaces, etc. decrease Wi-Fi strength.)
- Check the cable that connects the Modem to the Router (if you use a separate Modem and Router) to see if it is in good condition. If it is not, replace the cable.
- Connect the TV to your Modem/Router using a CAT 7 cable, and then try to set up a wired network connection. (**MENU > Network > Network Settings**).
- Check **Network Status (MENU > Network > Network Status)** to see if the IP address is invalid, for example, 169.x.x.x. If it is, call your ISP to get a valid IP address, and then ask them to check the connection between your Modem and Router and the connection between the Modem / Router and the Internet.
- If you see a valid Mac address, call your ISP and ask them to reset your network circuit to re-register the Mac addresses of your new Modem/Router and the TV.

## Netflix problems

- Verify that your Modem/Router is no more than 50 ft (15.2 m) away from the TV.
- Change the DNS to 8.8.8.8. Select **MENU > Network > Network Status > DNS Server > Select Manually > DNS > enter 8.8.8.8 > OK**
- Verify that the ESN for Netflix is valid. (Go to **MENU > Support > Contact Samsung**)  
Reset Netflix by selecting **MENU > Smart Hub > Smart Hub Reset**.

## Smart Hub Error Messages

- Verify that the distance between the TV and the Modem/Router does not exceed 50 ft (15.2 m).
- Verify that the TV is connected to the network by checking the **Network Status (MENU > Network > Network Status)**.
- Reset Smart Hub by selecting the **MENU > Smart Hub > Smart Hub Reset**.
- Update the TV's software (**MENU > Support > Software Update**).
- Wait 2 to 3 days for the issue to resolve itself.

## Eco Sensor and Screen Brightness

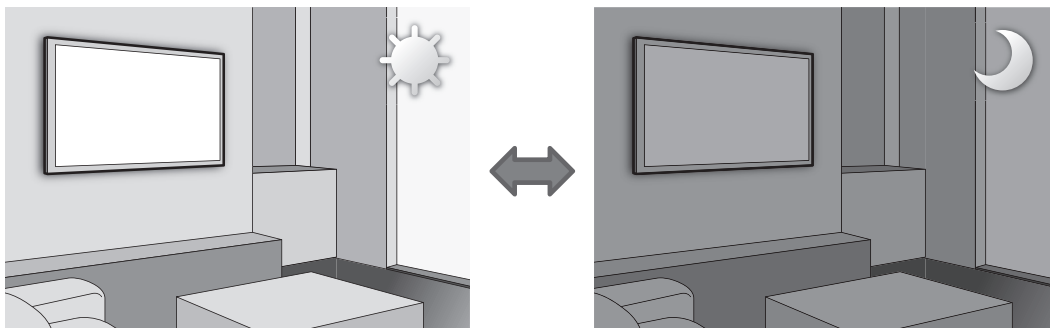

Eco Sensor measures the light in your room and optimizes the brightness of the TV automatically to reduce power consumption. This causes the TV to brighten and dim automatically. If you want to turn this off, go to **MENU > System > Eco Solution > Eco Sensor**.

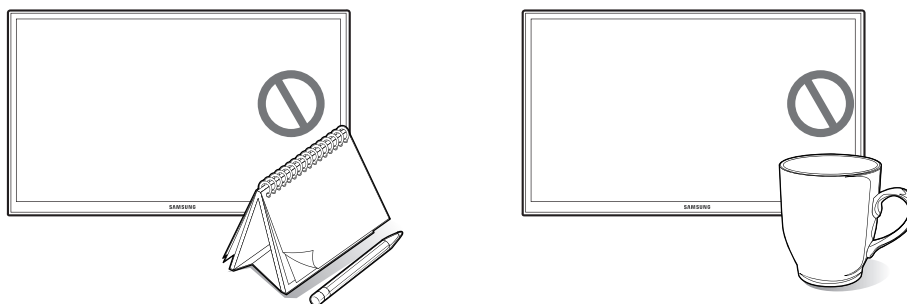

Do not block the sensor with any object. It can decrease picture brightness.

### Preventing burn-in.

Avoid keeping a still picture or a picture with static elements (black bars, black borders, logos, etc.) on your TV for more than two hours at a time. If that is unavoidable, change the picture or change to another channel for a minute or two every couple of hours. Reducing the brightness and contrast of the screen when it is displaying static elements will also help.

## Getting Remote Support

Samsung Remote Support service offers you one-on-one support with a Samsung Technician who can remotely:

- **Diagnose** your TV
- **Adjust the TV settings** for you
- **Perform a factory reset** on your TV
- Install recommended **firmware updates**

## How Does Remote Support Work?

Having a Samsung Tech remotely service your TV is easy.



1. **Call the Samsung Contact Center** and ask for remote support.



2. **Open the menu on your TV and go to the Support section.**



3. **Select Remote Management**, and then read and agree to the service agreements. When the PIN screen appears, provide the PIN number to the agent.



4. The agent will then **access your TV**. That's it!

## Caring for the TV

- If a sticker was attached to the TV screen, some debris can remain after you remove the sticker. Please clean the debris off before watching TV.
- The exterior and screen of the product can get scratched during cleaning. Be sure to wipe the exterior and screen carefully using a soft cloth to prevent scratches.

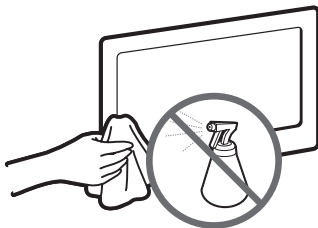

Do not spray water or any liquid directly onto the TV. Any liquid that goes into the product may cause a failure, fire, or electric shock.

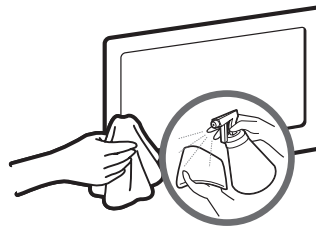

Turn off the TV, and then gently wipe away smudges and fingerprints on the screen with a micro-fiber cloth. Clean the body of the TV with a soft cloth dampened with a small amount of water. Do not use flammable liquids (benzene, thinners, etc.) or a cleaning agent. For stubborn smudges, spray a small amount of screen cleaner on the cloth.

# 07. Specifications, wall mounting, and other information

## Specifications

Display Resolution	1920 x 1080	
Environmental Considerations		
Operating Temperature	50°F to 104°F (10°C to 40°C)	
Operating Humidity	10% to 80%, non-condensing	
Storage Temperature	-4°F to 113°F (-20°C to 45°C)	
Storage Humidity	5% to 95%, non-condensing	
Stand Swivel (Left / Right)	0°	
Model Name	UN46H7150	UN55H7100 / UN55H7150
Screen Size (Diagonal)	46" Class (45.9 measured diagonally)	55" Class (54.6 measured diagonally)
Sound (Output)	40W (Left:10W, Right:10W, Woofer:20W)	
Dimensions (W x H x D)		
Body	40.6 x 23.5 x 1.3 inches (1033.3 x 596.9 x 33.2 mm)	48.2 x 27.8 x 1.3 inches (1224.8 x 706.9 x 33.2 mm)
With stand	40.6 x 25.1 x 8.2 inches (1033.3 x 639.2 x 208.8 mm)	48.2 x 29.4 x 10.5 inches (1224.8 x 747.5 x 267.7 mm)
Weight		
Without Stand	24.9 lbs (11.3 kg)	32.6 lbs (14.8 kg)
With Stand	27.5 lbs (12.5 kg)	36.8 lbs (16.7 kg)
Model Name	UN60H7100 / UN60H7150	UN65H7100 / UN65H7150
Screen Size (Diagonal)	60" Class (60.0 measured diagonally)	65" Class (64.5 measured diagonally)
Sound (Output)	40W (Left:10W, Right:10W, Woofer:20W)	
Dimensions (W x H x D)		
Body	53.6 x 31.2 x 1.3 inches (1362.1 x 792.7 x 34.2 mm)	56.9 x 32.9 x 1.3 inches (1447.3 x 836.4 x 35.2 mm)
With stand	53.6 x 32.7 x 10.5 inches (1362.1 x 833.1 x 267.7 mm)	56.9 x 34.8 x 11.8 inches (1447.3 x 886.1 x 301.8 mm)
Weight		
Without Stand	42.1 lbs (19.1 kg)	49.3 lbs (22.4 kg)
With Stand	46.5 lbs (21.1 kg)	55.1 lbs (25.0 kg)

Model Name	UN75H7100 / UN75H7150
Screen Size (Diagonal)	75" Class (74.5 measured diagonally)
Sound (Output)	40W (Left:10W, Right:10W, Woofer:20W)
Dimensions (W x H x D) Body	65.7 x 37.8 x 1.4 inches (1670.2 x 962.6 x 36.4 mm)
With stand	65.7 x 39.8 x 12.4 inches (1670.2 x 1012.3 x 316.9 mm)
Weight Without Stand	74.9 lbs (34.0 kg)
With Stand	81.7 lbs (37.1 kg)

- Design and specifications are subject to change without prior notice.
- The actual appearance of the TV may differ from the images in this manual, depending on the model.
- This device is a Class B digital apparatus.
- For information about the power supply, and more information about power consumption, refer to the label attached to the product.
- Typical power consumption is measured according to Energy Star Program requirements for Televisions.

Dispose unwanted electronics through an approved recycler.

To find the nearest recycling location, go to our website:

[www.samsung.com/recyclingdirect](http://www.samsung.com/recyclingdirect) or call, (877) 278 - 0799

## Decreasing Power Consumption

When you shut the TV off, it enters Standby mode. In Standby mode, it continues to draw a small amount of power. To decrease power consumption, unplug the power cord when you don't intend to use the TV for a long time.

# Dimensions

Port panel detail / Rear view

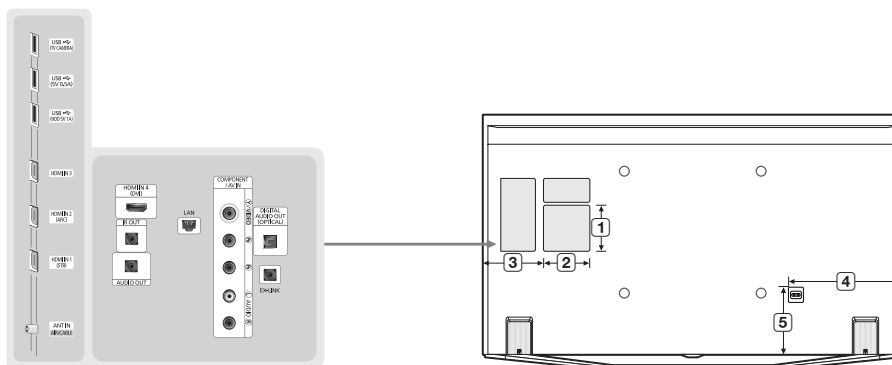

- The displayed image may differ depending on the model.

(Unit: inches)

Model name	①	②	③	④	⑤
UN46H7150	5.1	5.0	5.8	11.4	10.3
UN55H7100 / UN55H7150	5.1	5.0	7.1	13.5	12.8
UN60H7100 / UN60H7150	5.1	5.0	9.8	16.2	14.5
UN65H7100 / UN65H7150	5.1	5.0	10.0	17.6	12.1
UN75H7100 / UN75H7150	5.1	5.0	14.3	22.0	14.5

All drawings are not necessarily to scale. Some dimensions are subject to change without prior notice. Refer to the dimensions before installing your TV. Not responsible for typographical or printed errors.

© 2014 Samsung Electronics America, Inc



## Licenses



## HDMI

The terms HDMI and HDMI High-Definition Multimedia Interface, and the HDMI Logo are trademarks or registered trademarks of HDMI Licensing LLC in the United States and other countries.

### Still image warning

Avoid displaying still images (such as jpeg picture files), still image elements (such as TV channel logos, stock or news crawls at the screen bottom etc.), or programs in panorama or 4:3 image format on the screen. Constantly displaying still pictures can cause image burn-in on the LED screen, which will affect image quality. To reduce risk of this effect, please follow the recommendations below:

- Avoid displaying the same TV channel for long periods.
- Always try to display any image in full screen. Use the TV set's picture format menu for the best possible match.
- Reduce brightness and contrast to avoid the appearance of after-images.
- Use all TV features designed to reduce image retention and screen burn. Refer to the e-Manual for details.

# Mounting the TV on a Wall Using the Wall Mount Kit (Optional)



If you mount this product on a wall, it should be mounted only as recommended by the manufacturer. Unless it is correctly mounted, the product may slide or fall, causing serious injury to a child or adult, and serious damage to the product.

## Installing the Wall Mount Kit

The wall mount kit (sold separately) lets you mount the TV on the wall.

For detailed information about installing the wall mount, see the instructions provided with the wall mount kit. We recommend you contact a technician for assistance when installing the wall mount bracket. We do not advise you to do it yourself. Samsung Electronics is not responsible for any damage to the product or injury to yourself or others if you select to install the wall mount on your own.

To order the wall mount kit, contact Samsung Customer Care at 1-800-SAMSUNG (1-800-726-7864).

## Installing a Wall Mount Using the Wall Mount Adapter

Wall mount adapters are provided only with 65-inch or bigger TV's.

Before installing any wall mount kit, install the wall mount adapters provided with the TV.

- Refer to the Installation Manual included with the Samsung wall mount kit.

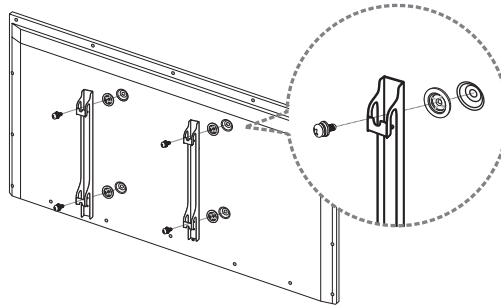

## VESA Wall Mount Kit Notes and Specifications

Install your wall mount on a solid wall perpendicular to the floor. Before attaching the wall mount to surfaces other than plaster board, please contact your nearest dealer for additional information. If you install the TV on a ceiling or slanted wall, it may fall and result in severe personal injury.

Product Family	TV size in inches	VESA screw hole specs (A * B) in millimeters	Standard Screw	Quantity	
LED-TV	40	200 X 200	M8	4	
	46 - 75	400 X 400			



**Do not install your Wall Mount Kit while your TV is turned on. It may result in personal injury from electric shock.**

- Standard dimensions for wall mount kits are shown in the table.
- Samsung wall mount kits contain a detailed installation manual, and all parts necessary for assembly are provided.
- Do not use screws that do not comply with VESA standard screw specifications.
- Do not use screws that are longer than the standard length or do not comply with VESA standard screw specifications. Screws that are too long may cause damage to the inside of the TV set.
- For wall mounts that do not comply with the VESA standard screw specifications, the length of the screws may differ depending on the wall mount specifications.
- Do not fasten the screws too firmly. This may damage the product or cause the product to fall, leading to personal injury. Samsung is not liable for these kinds of accidents.
- Samsung is not liable for product damage or personal injury when a non-VESA or non-specified wall mount is used or the consumer fails to follow the product installation instructions.
- Do not mount the TV at more than a 15 degree tilt.
- Always have two people mount the TV on to a wall.

## Providing Proper Ventilation for Your TV

When you install your TV, maintain a distance of at least 4 inches between the TV and other objects (walls, cabinet sides, etc.) to ensure proper ventilation. Failing to maintain proper ventilation may result in a fire or a problem with the product caused by an increase in its internal temperature.

If you use parts provided by another manufacturer, it may cause difficulties with the product or result in injury caused by the product falling.

- Whether you install your TV using a stand or a wall-mount, we strongly recommend you use parts provided by Samsung Electronics only.

**Installation with a stand.**

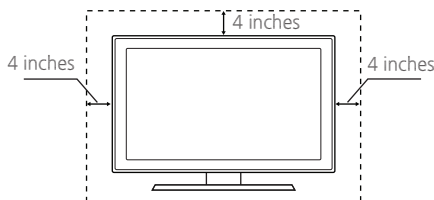

**Installation with a wall-mount.**

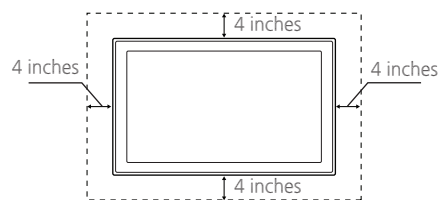

## Securing the TV to the Wall



**Caution:** Pulling, pushing, or climbing on the TV may cause the TV to fall. In particular, ensure your children do not hang on or destabilize the TV. Doing so may cause the TV to tip over, causing serious injuries or death. Follow all safety precautions provided in the Safety Flyer included with your TV. For added stability and safety, you can purchase and install the anti-fall device as described below.

### To Prevent the TV from Falling

These are general instructions. The clamps, screws, and string are not supplied by Samsung. They must be purchased separately. We suggest consulting an installation service or professional TV installer for specific hardware and anti-fall hardware installation.

1. Put the screws into the clamps and firmly fasten them onto the wall. Confirm that the screws have been firmly installed onto the wall.
  - You may need additional material such as an anchor depending on the type of wall.
2. Remove the screws from the back center of the TV, put the screws into the clamps, and then fasten the screws onto the TV again.
  - These screws may not be supplied with the TV. If they are not, purchase screws with the following specifications:
    - For a 40 - 75 inches models: M8

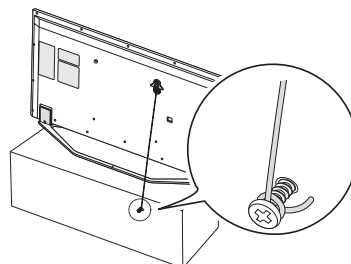

3. Connect the clamps fixed onto the TV and the clamps fixed onto the wall with a durable, heavy-duty string and then tie the string tightly.

#### NOTE

- Install the TV near to the wall so that it does not fall backwards.
  - Connect the string so that the clamps fixed on the wall are at the same height to or lower than the clamps fixed on the TV.
  - Untie the string before moving the TV.
4. Verify all connections are properly secured. Periodically check the connections for any sign of fatigue or failure. If you have any doubt about the security of your connections, contact a professional installer.

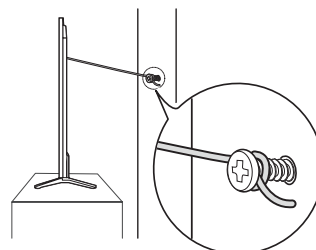

## Warranty Information

### Federal Communication Commission Interference Statement

This equipment has been tested and found to comply with the limits for a Class B digital device, pursuant to Part 15 of the FCC Rules. These limits are designed to provide reasonable protection against harmful interference in a residential installation. This equipment generates, uses and can radiate radio frequency energy and, if not installed and used in accordance with the instructions, may cause harmful interference to radio communications. However, there is no guarantee that interference will not occur in a particular installation. If this equipment does cause harmful interference to radio or television reception, which can be determined by turning the equipment off and on, the user is encouraged to try to correct the interference by one of the following measures:

- Reorient or relocate the receiving antenna.
- Increase the separation between the equipment and receiver.
- Connect the equipment into an outlet on a circuit different from that to which the receiver is connected.
- Consult the dealer or an experienced radio/TV technician for help.

FCC Caution: Any changes or modifications not expressly approved by the party responsible for compliance could void the user's authority to operate this equipment.

This device complies with Part 15 of the FCC Rules. Operation is subject to the following two conditions: (1) This device may not cause harmful interference, and (2) this device must accept any interference received, including interference that may cause undesired operation.

For product available in the USA/Canada market, only channel 1~11 can be operated. Selection of other channels is not possible.

This device and its antenna(s) must not be co-located or operation in conjunction with any other antenna or transmitter.

### FCC Radiation Exposure Statement:

This equipment complies with FCC radiation exposure limits set forth for an uncontrolled environment. This equipment should be installed and operated with minimum distance 20cm between the radiator & your body.

## IMPORTANT WARRANTY INFORMATION REGARDING TELEVISION FORMAT VIEWING

- See the warranty card for more information on warranty terms.

Wide screen format LED Displays (with 16:9 aspect ratios, the ratio of the screen width to height) are primarily designed to view wide screen format full-motion video. The images displayed on them should primarily be in the wide screen, 16:9 ratio format, or expanded to fill the screen, if your model offers this feature, with the images constantly in motion. Displaying stationary graphics and images on the screen, such as the dark sidebars on non-expanded standard format television video and programming, should be limited to no more than 5% of the total television viewing time per week.

Additionally, viewing other stationary images and text such as stock market crawls, video game displays, station logos, web sites or computer graphics and patterns, should be limited as described above for all televisions.

Displaying stationary images that exceed the above guidelines can cause uneven aging of LED Displays that leave subtle, but permanent burned-in ghost images in the LED picture. To avoid this, vary the programming and images, and primarily display full screen moving images, not stationary patterns or dark bars. On LED models that offer picture sizing features, use these controls to view different formats as a full screen picture.

Be careful about the television formats you select and the length of time you view them. Uneven LED aging as a result of format selection and use, as well as burned in images, are not covered by your Samsung limited warranty.

- SAMSUNG ELECTRONICS NORTH AMERICAN LIMITED WARRANTY STATEMENT

Subject to the requirements, conditions, exclusions and limitations of the original Limited Warranty supplied with Samsung Electronics (SAMSUNG) products, and the requirements, conditions, exclusions and limitations contained herein, SAMSUNG will additionally provide Warranty Repair Service in the United States on SAMSUNG products purchased in Canada, and in Canada on SAMSUNG products purchased in the United States, for the warranty period originally specified, and to the Original Purchaser only.

The above described warranty repairs must be performed by a SAMSUNG Authorized Service Center. Along with this Statement, the Original Limited Warranty Statement and a dated Bill of Sale as Proof of Purchase must be presented to the Service Center. Transportation to and from the Service Center is the responsibility of the purchaser. Conditions covered are limited only to manufacturing defects in material or workmanship, and only those encountered in normal use of the product.

Excluded, but not limited to, are any originally specified provisions for, in-home or on-site services, minimum or maximum repair times, exchanges or replacements, accessories, options, upgrades, or consumables.

For the location of a SAMSUNG Authorized Service Center, please call toll-free:

- In the United States: 1-800-SAMSUNG (1-800-726-7864)
- In Canada: 1-800-SAMSUNG

## SAMSUNG BRAND PRODUCTS

### LIMITED WARRANTY TO ORIGINAL PURCHASER

This SAMSUNG brand product, as supplied and distributed by SAMSUNG and delivered new, in the original carton to the original consumer purchaser, is warranted by SAMSUNG against manufacturing defects in materials and workmanship for period of: (90 Days Parts and Labor for Commercial Use)

Categories	Parts	Labor	Size	Service
LCD/LED TV	1 Year	1 Year	39" and Larger 37" and Smaller	Carry-In or In Home Carry-In
Plasma Display	1 Year	1 Year	All	Carry-In or In Home
3D Glasses	1 Year	1 Year	-	Carry-In or Pick up

\*\* 180 Days after Purchasing and 600 Hours of Use Lamp on Projector

This limited warranty begins on the original date of purchase, and is valid only on products purchased and used in the United States. To receive warranty service, the purchaser must contact SAMSUNG for problem determination and service procedures.

Warranty service can only be performed by a SAMSUNG authorized service center. The original dated bill of sale must be presented upon request as proof of purchase to SAMSUNG or SAMSUNG's authorized service center.

SAMSUNG will repair or replace this product, at our option and at no charge as stipulated herein, with new or reconditioned parts or products if found to be defective during the limited warranty period specified above. All replaced parts and products become the property of SAMSUNG and must be returned to SAMSUNG. Replacement parts and products assume the remaining original warranty, or ninety (90) days, whichever is longer.

Certain products are eligible for In-home service at Samsung's discretion. To receive in-home service, the product must be unobstructed and accessible to service personnel. If during in-home service, repair cannot not be completed, it may be necessary to remove, repair and return the product. If in-home service is unavailable, SAMSUNG may elect, at our option, to provide for transportation of our choice to and from a SAMSUNG authorized service center. Otherwise, and for 37" and smaller LCD/LED TV, transportation to and from the SAMSUNG authorized service center is the responsibility of the purchaser.

This limited warranty covers manufacturing defects in materials and workmanship encountered in normal, and except to the extent otherwise expressly provided for in this statement, noncommercial use of this product, and shall not apply to the following, including, but not limited to: damage which occurs in shipment; delivery and installation; applications and uses for which this product was not intended; altered product or serial numbers; cosmetic damage or exterior finishes; accidents, abuse, neglect, fire, water, lightning or other acts of nature; use of products, equipment, systems, utilities, services, parts, supplies, accessories, applications, installations, repairs, external wiring or connectors not supplied or authorized by SAMSUNG which damage this product or result in service problems; incorrect electrical line voltage, fluctuations and surges; customer adjustments and failure to follow operating instructions, cleaning, maintenance and environmental instructions that are covered and prescribed in the instruction book; reception problems and distortion related to noise, echo, interference or other signal transmission and delivery problems; brightness related to normal aging, or burned-in images. SAMSUNG does not warrant uninterrupted or error-free operation of the product.

THERE ARE NO EXPRESS WARRANTIES OTHER THAN THOSE LISTED AND DESCRIBED ABOVE, AND NO WARRANTIES WHETHER EXPRESS OR IMPLIED, INCLUDING, BUT NOT LIMITED TO, ANY IMPLIED WARRANTIES OF MERCHANTABILITY OR FITNESS FOR A PARTICULAR PURPOSE, SHALL APPLY AFTER THE EXPRESS WARRANTY PERIODS STATED ABOVE, AND NO OTHER EXPRESS WARRANTY OR GUARANTY GIVEN BY ANY PERSON, FIRM OR CORPORATION WITH RESPECT TO THIS PRODUCT SHALL BE BINDING ON SAMSUNG. SAMSUNG

SHALL NOT BE LIABLE FOR LOSS OF REVENUE OR PROFITS, FAILURE TO REALIZE SAVINGS OR OTHER BENEFITS, OR ANY OTHER SPECIAL, INCIDENTAL OR CONSEQUENTIAL DAMAGES CAUSED BY THE USE, MISUSE OR INABILITY TO USE THIS PRODUCT, REGARDLESS OF THE LEGAL THEORY ON WHICH THE CLAIM IS BASED, AND EVEN IF SAMSUNG HAS BEEN ADVISED OF THE POSSIBILITY OF SUCH DAMAGES. NOR SHALL RECOVERY OF ANY KIND AGAINST SAMSUNG BE GREATER IN AMOUNT THAN THE PURCHASE PRICE OF THE PRODUCT SOLD BY SAMSUNG AND CAUSING THE ALLEGED DAMAGE. WITHOUT LIMITING THE FOREGOING, PURCHASER ASSUMES ALL RISK AND LIABILITY FOR LOSS, DAMAGE OR INJURY TO PURCHASER AND PURCHASER'S PROPERTY AND TO OTHERS AND THEIR PROPERTY ARISING OUT OF THE USE, MISUSE OR INABILITY TO USE THIS PRODUCT SOLD BY SAMSUNG NOT CAUSED DIRECTLY BY THE NEGLIGENCE OF SAMSUNG. THIS LIMITED WARRANTY SHALL NOT EXTEND TO ANYONE OTHER THAN THE ORIGINAL PURCHASER OF THIS PRODUCT, IS NONTRANSFERABLE AND STATES YOUR EXCLUSIVE REMEDY.

Some states do not allow limitations on how long an implied warranty lasts, or the exclusion or limitation of incidental or consequential damages, so the above limitations or exclusions may not apply to you. This warranty gives you specific legal rights, and you may also have other rights which vary from state to state.

To obtain warranty service, please contact SAMSUNG at:

Samsung Electronics America, Inc.  
85 Challenger Road  
Ridgefield Park, NJ 07660-2112

1-800-SAMSUNG 726-7864 - [www.samsung.com](http://www.samsung.com)  
1-800-749-0260: Projectors only

The benefits of this Limited Warranty extend only to the original purchaser of Samsung products from an authorized Samsung reseller. THIS LIMITED WARRANTY SHALL NOT APPLY TO ANY SAMSUNG PRODUCTS PURCHASED FROM UNAUTHORIZED RESELLERS OR RETAILERS, EXCEPT IN STATES WHERE SUCH RESTRICTION MAY BE PROHIBITED. For a list of Samsung authorized retailers, please go to: [http://www.samsung.com/us/peaceofmind/authorized\\_resellers.html](http://www.samsung.com/us/peaceofmind/authorized_resellers.html).

***This page is intentionally  
left blank.***